

A close-up photograph of a person's gloved hand using a heat gun to weld a green metal chair frame. The heat gun is orange and black, and the person is wearing a white glove. The background shows a factory setting with other chairs in various colors (yellow, green) and a blurred industrial environment.

fermob 

TECHNICAL BOOKLET - 2024

**TIP !**

Unfold your colour chart  
and refer to it as you browse  
through the Technical Booklet.

**A5 - Clay Grey**

*Textured*

OTF

**C7 - Lapilli Grey**

*Textured*

**26 - Storm Grey**

*Speckled textured*

OTF

**47 - Anthracite**

*Speckled textured*

OTF

**42 - Liquorice**

*Textured*

**92 - Deep Blue**

*Textured*

**21 - Acapulco Blue**

*Textured*

OTF

**02 - Cedar Green**

*Textured*

**48 - Rosemary**

*Textured*

OTF

**82 - Cactus**

*Textured*

OTF

**65 - Willow Green**

*Speckled textured*

**D3 - Pesto**

*Textured*

NEW

**D2 - Gingerbread**

*Textured*

NEW

**14 - Nutmeg**

*Speckled textured*

OTF

**B9 - Black Cherry**

*Textured*

NEW

OTF

**20 - Red Ochre**

*Textured*

OTF

**43 - Chili**

*Textured*

OTF

**67 - Poppy**

*Smooth*

**45 - Capucine**

*Textured*

**C6 - Honey**

*Textured*

**A6 - Frosted Lemon**

*Textured*

**A7 - Ice Mint**

*Textured*

**83 - Opaline Green**

*Textured*

**D1 - Marshmallow**

*Textured*

NEW

**01 - Cotton White**

*Textured*



A5 - Clay Grey	C7 - Lapilli Grey	47 - Anthracite	42 - Liquorice	92 - Deep Blue	21 - Acapulco Blue	02 - Cedar Green	48 - Rosemary	82 - Cactus	D2 - Gingerbread	I4 - Nutmeg	B9 - Black Cherry	20 - Red Ochre	67 - Poppy	45 - Capucine	C6 / 73 - Honey	A6 - Frosted Lemon	A7 - Ice Mint	83 - Opaline Green
----------------	-------------------	-----------------	----------------	----------------	--------------------	------------------	---------------	-------------	------------------	-------------	-------------------	----------------	------------	---------------	-----------------	--------------------	---------------	--------------------

### PARASOLS & ACCESSORIES

ACCROCHE COEURS	Coat stand								NEW									
ACROBATE	Peg								NEW									
ALTO	Collection								NEW									
BOUQUET SAUVAGE	Trivet cactus							NEW										
	Trivet Monstera						NEW											
IOS	Single-stem vase								NEW									
ITAC	Collection								NEW									
PICOTI	Bird feeder	NEW							NEW									
LORETTE	Trivet												NEW					
TRÈFLE	Trivet		NEW								NEW							

### LIGHTING

APLÔ	Lamp H.24																	
	Wall light bracket																	
	Suspension trap																	
	Magnetic base																	
	Upright stand	NEW																
BALAD	Set of 3 lamps H.12																	
	Lamp H.25																	
	Lamp H.38																	
	Upright stand																	
	Offset stand																	
HOOPIK	Spike stand																	
	String lights L1200 Type E & F																	
	String lights L1200 Type I																	
	String lights L1200 Type J																	
	Lamp Ø 24	NEW																
INOUI	Lighting stool H.44																	
LUDO	Smart switch																	
MOON!	Wall light Ø 15																	
	Lamp H.41																	
	Lamp H.41 MAX	NEW																
	Lamp H.63																	
	Lamp H.134																	
	Triple pendant lights Ø 15	NEW																
	Pendant lights Ø 25	NEW																
OTO	Lamp H.27	NEW																
ULLI	Lamp H.30	NEW																

# FERMOB

## IN A FEW DATES

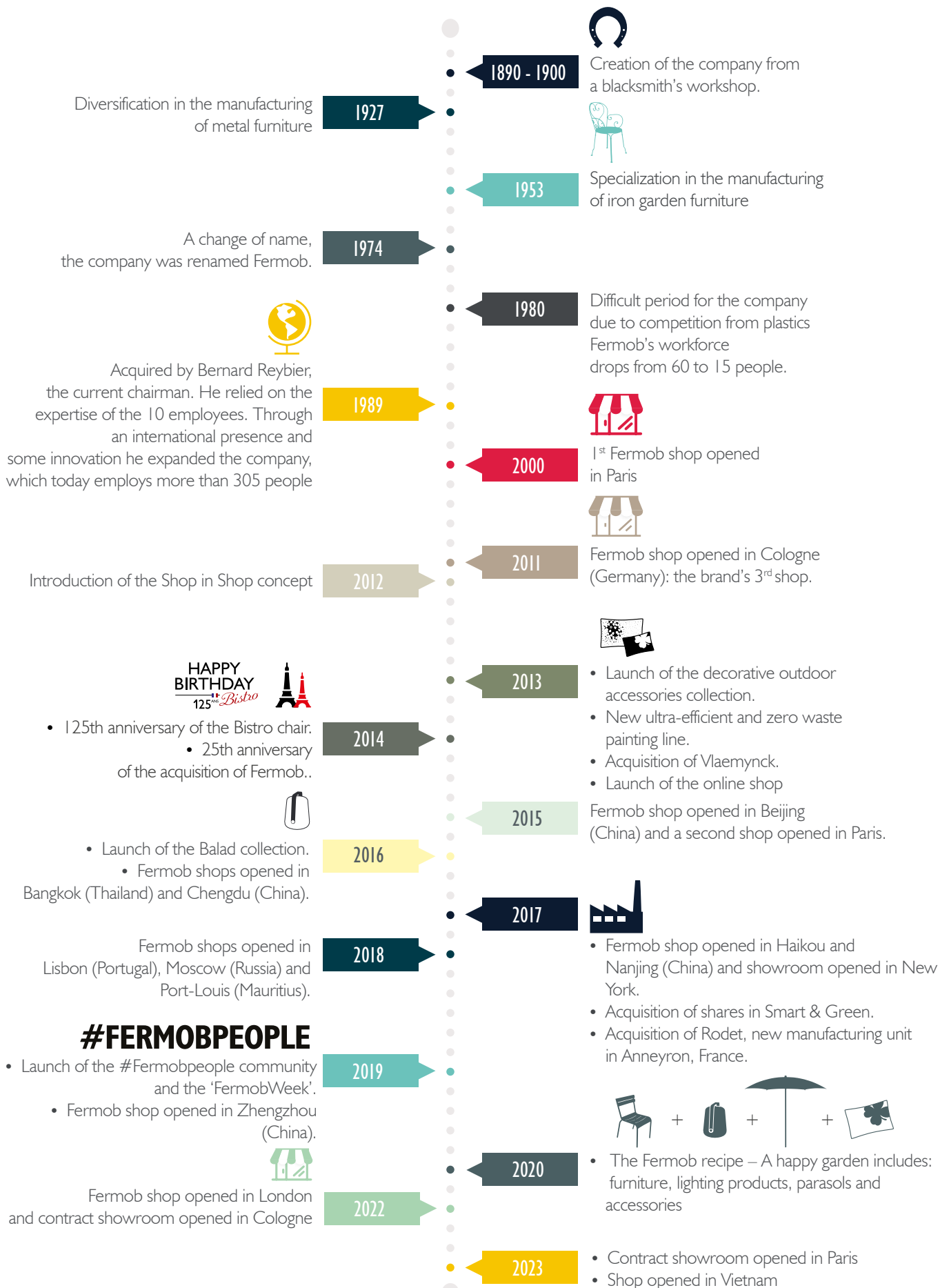

# WELCOME

TO FERMOB

A French company that relies on three high-performance industrial sites located near Lyon

- Thoissey: 14,000 m<sup>2</sup>
- Macôn: 10,000 m<sup>2</sup>
- Anneyron: 24,000 m<sup>2</sup>
- Including more than 305 employees
- Turnover of € 121 M in 2022

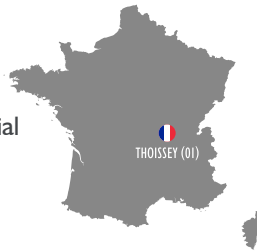

Manufacturing with creative added value

- In-house design studio

A strong reputation in France and abroad, among the general public and professionals

- Marketing in more than 65 countries
- 50% of turnover from exports

Strong values deeply rooted in the culture of the brand and the company

- Joie de vivre
- Affordable
- Inspiring
- Detail-oriented

## Fermob: Metalwork

- A splendid and inspiring material
- More than 5,000 tonnes of metal (steel and aluminium) transformed annually
- More than 690,000 parts manufactured annually
- More than 200,000 metal Bistro chairs manufactured in the Thoissey factory each season

## Expertise: the mastery of colour

- A unique colour palette with a colour chart composed of 25 colours, updated every year to combine, attract and inspire...

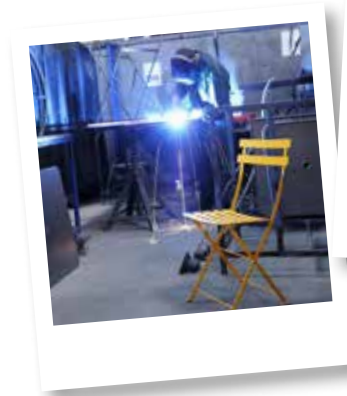

You can use our product daily all over the world :



Times Square, New York - USA



Coca-Cola Museum, Atlanta - USA



Grace Santorini Hotel, Santorin - GREECE



Molitor, Paris - FRANCE



FROM PARIS  
TO NEW YORK,  
TO SINGAPORE



Mc Donald's, Lyon - FRANCE



Bikini Hotel, Berlin - GERMANY



Maxx Royal Hotel, Antalya - TÜRKIYE

# FERMOB

THE ART OF GOOD LIVING FOR EVERY SPACE

Cafés that come to life with different chair arrangements, afternoons spent lazing in an armchair under a pergola, meals shared with loved ones around a dining table, a table lamp that can be snuck into the garden to light up your kitchen table...

Since 1989, Fermob has been creating a universal and immediate link between the environment and its inhabitants, bringing reality to life moments, where art and lifestyle are guided by high quality, meaningful design.

Our furniture has timeless appeal: the perfect illustration of French style that has been adopted world-wide. The French brand adorns the world's largest squares as well as tiny Parisian balconies, while also breathing its boundless, colourful energy into every space.

Today, it has not only revolutionized existing outdoor spaces and taken away the barrier between indoor and outdoor living, it also promotes smart ways to merge the spaces.

The furniture thus plays the complementarity card, adopting new materials and colours to step indoors.

Multi-purpose lamps design atmospheres to set the mood from the garden to the living room.



The result?

Avant-garde pieces by designers who combine expert craftsmanship with industrial performance and creative audacity to meet the flexible needs of today's spaces.

A colour chart with 25 shades and a range of clever accessories that create lasting emotions for unique locations that reflect every personality.

This year, Fermob has introduced new materials to its ranges -wood and leather, Exploring the indoor world with new versions of its emblematic products.

In the open air or inside the home, we all have a Fermob experience to enjoy.





# FERMOB

MANUFACTURER OF FURNITURE DESIGNED FOR OUTDOOR USE

Fermob has been designing and manufacturing outdoor furniture for 35 years. A universe that requires specific expertise and know-how through adapted materials and treatments.

## FERMOB: MATERIALS AND TREATMENTS FOR OUTDOOR USE



## FERMOB : THE COLOUR EXPERT

### A UNIQUE RANGE

**Fermob has been famous for colour** since 1996. Bernard Reybier quickly understood colour is what makes a garden distinctive, creates atmosphere on a terrace, adds **personality to an item of furniture and establishes a sense of boldness**...

In a market that was once limited to two shades (English Green and White), the brand revolutionised the sector by offering an **original colour chart of bright, intense and contrasting colours**. Today, Fermob has further developed its **colour expertise** with more **subtle shades**, making it possible to **play with different hues** and compose your own palette. **25 unique colours**, 25 ways to make our furniture happy, 25 degrees of intensity, 25 shades of light... Our colours are designed to flourish out there on their own, to be **coordinated** and **bring out the best in each other**. For an **infinite number of combinations**, plenty to make every terrace and patio unique.

We add one or two new shades to our colour chart every year.

Our colours are fit for **demanding outdoor use**. We carry out intensive testing before every launch, so that we can guarantee:

- **lightfastness**
- **scratch resistance**
- **UV resistance**
- **moisture resistance**



## HIGH PERFORMANCE INDUSTRIAL FACILITIES

The company has ensured that it has the means to achieve its ambitions and now owns **the most advanced painting line anywhere in the world** ! It takes just **6 minutes to change paint colours** and the line can handle every shade of the colour chart in just 3 days, proving this impressive industrial tool's **flexibility and reactivity**.

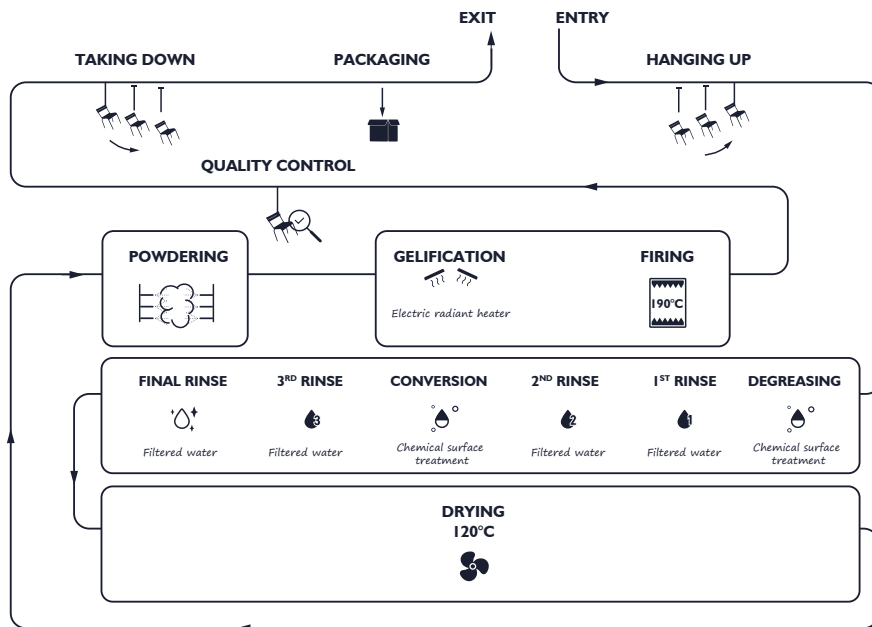

Painting process on the historic Thoissey site



All Fermob metal products are painted with a **100% polyester powder coating**, which offers better UV resistance than standard epoxy paints. The paint is **applied electrostatically to the furniture for an optimal coverage**, then baked at very high temperature.

To improve anti-corrosion performance, we apply **surface treatments** (galvanisation, electro-galvanisation, electrolytic coating) **before painting, either as standard or as an added option**.



**Electro galvanising** : Protecting an object by applying a layer of zinc using electrolysis (electrical energy).

**Galvanisation**: Iron protection process that involves dipping a part into a bath of melted zinc.

**Electrolytic coating** : A surface treatment originally used in the automotive industry. An electrophoresis paint (sub-layer) technique where a part is immersed in a bath of water-soluble paint. Electrolytic coating means that the product benefits from Very High Protection treatment and is suited to intensive use or use in extremely wet/humid environments.

**Electrostatic** : An eco-friendly painting technique that involves using powder instead of solvent-based paints. An electrostatic force attracts the powder coating to the metal, achieving optimal coverage. The coating is then baked onto the furniture.

## FERMOB: A UNIQUE KNOW-HOW

### THE METAL: WONDERFUL MATERIAL OF IDEAS

For our furniture, we choose to use **metal** (over 98% recyclable) – the “**material of ideas**”, as Gustave Eiffel put it – on account of its incredible versatility. The metals we use are **premium-grade steel and aluminium**.



#### STEEL

- Fermob's original expertise
- Stable and durable
- Creates an elegant design



#### ALUMINIUM

- Malleable
- Light-weight
- Easy to weld



**Cold-rolled steel** : The laminated steel is passed through a set of rollers, which transform it into material (e.g. into sheet for table top). Cold rolling is Fermob's technique of choice, since it makes the steel resistant, gives it a precise, uniform thickness, and promotes good paint hold.

Whenever our designers and technicians are working on a new product, **anti-corrosion performance is always top of mind**. We're constantly thinking of ways to eradicate, or at least reduce, areas that could be prone to corrosion because they are not protected or treated.

Examples of **corrosion-prone areas** include:

- rims under table tops
- air gaps
- tubular parts
- areas subject to friction, such as folding mechanisms
- areas where the properties of the material have changed as a result of heat (such as from laser cutting or welding).

Fermob furniture benefits from anti-corrosion treatment specifically for outdoor use and undergoes intensive tests at our laboratories, in accordance with **general standards on safety** (NF EN 581-1), **stability** (NF EN 1022), and **resistance and durability** for collective use (NF EN 581-2, NF EN 581-3).

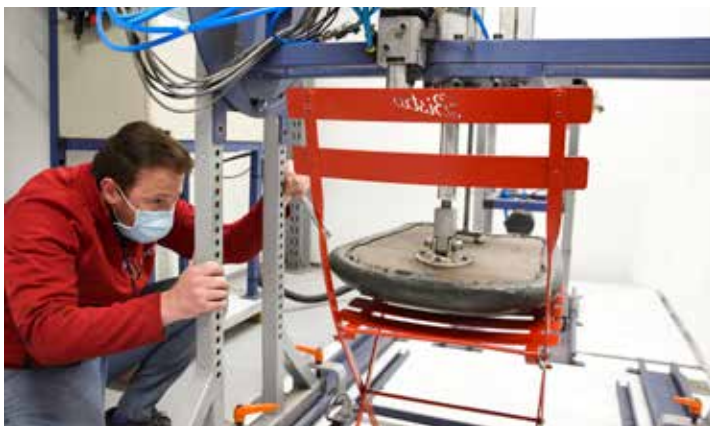



## ANTI-CORROSION PROTECTION RATING

Fermob has introduced a new **Anti-Corrosion Performance Rating (IPAC)** for all metal items of furniture. The rating is an indication of the product's anti-corrosion performance, combining three factors: **design, material and surface treatment**.

Since all our items of furniture are designed for outdoor use, we systematically apply a surface treatment and high-performance outdoor paint to offer the very best protection against corrosion.

**On a scale from 1 to 10, all Fermob furniture has a minimum IPAC rating of 6.**



All products bearing this logo are eligible for additional, **optional anti-corrosion treatment** (contact our sales department).

The 1st figure gives the basic rating and the **2nd figure in the upper right-hand corner gives the IPAC after additional treatment**. Depending on the products and their design, the IPAC enhancement may be different.



## MIXED-MATERIAL PRODUCTS

Metal can be combined with other materials such as **Outdoor Technical Fabric** (polyester coated with PVC), **thread** (woven polymer), **outdoor fabrics** developed in conjunction with reputable suppliers known for their exacting standards or **teak**.



OTF

*Outdoor Technical Fabric*



OUTDOOR FABRICS



THREAD

*Woven polymer*



TEAK



## OUTDOOR TECHNICAL FABRIC (DUO OR STEREO)

We use Batyline® **Outdoor Technical Fabrics** (OTFs) on our products, sourced from market-leading **French manufacturer Serge Ferrari**. The fabrics are made from **high-tenacity 100% polyester thread, protected with a solution-dyed PVC cover**, guaranteeing:

- a hard-wearing, tearproof product (can withstand loads of up to 4 tons per square metre)
- a seat that doesn't sag (the fabric retains its shape after use)
- a design look that lasts.

The manufacturer handles **all four phases of the production process in-house**:

- creating the polyester thread (core)
- extruding the PVC thread (cover)
- weaving the fabric
- heat weld the fabric.

Batyline® is the **best-performing outdoor fabric money can buy**. The Stereo fabric is developed **exclusively for Fermob**.

Batyline® is **particularly suited for an outdoor use** because it:

- is UV-resistant (colours do not fade over time)
- stays cool
- does not hold water
- anti-mould and anti-stain treated
- hypoallergenic
- offers a flexible and comfortable seat that retains its shape
- is easy to clean with soap and water.

**Serge Ferrari**



Batyline® DUO  
(Cactus)



Batyline® STEREO  
(Rosemary)

## THE 100% OUTDOOR FABRIC

The cushioned furniture (as well as some textile accessories) use **Sunbrella® fabric by Dickson, the French outdoor fabric specialist. 100% solution-dyed acrylic**, Sunbrella® fabrics are designed for **outdoor use**.

### WHAT MAKES A GOOD OUTDOOR FABRIC ?

- A fabric that has **technical qualities enabling it to withstand sustained outdoor use without deteriorating** (colour-fastness to UV rays, water-repellent, resistant to stains and mould, etc.)
- A fabric that's **easy to keep clean** (removable cover, machine-washable, etc.).



Colour-fast  
in the sun



Water-repellent  
treatment



Breathable:  
quick-drying



Anti-stain  
treatment



Tearproof and  
resistant to abrasion



Removable  
covers

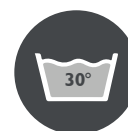

Machine  
Washable



**Abrasion** : Wear caused by rubbing.

**Water-repellent** : A water-repellent fabric does not instantly absorb water droplets. Instead, water slides off the surface. It reinforces the resistance to stains and mould. However, if the water is not removed quickly, it will end up being absorbed into the fibre (water-repellent is not the same as waterproof).

## WOVEN POLYMER THREAD

The seats in the Croisette and Sixties collections are handwoven on an aluminium frame. The wires are made from resin (polymer) before being **braided by hand, the traditional way**. This means that each item is unique, and requires 8 to 19 hours of manual work.

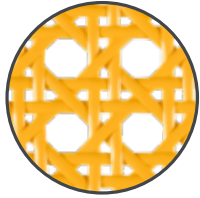

Croisette collection

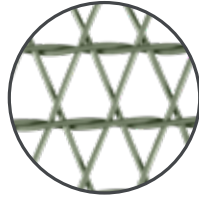

Sixties collection



The **Croisette** collection reinvents **traditional wickerwork**, using **textured flat weave**.

The **Sixties** collection stands out with its visually **striking retro effect**. The seats are braided using a **round “scoobie” weave**.

## TEAK EXPERTISE IN THE FERMOB GROUP

Fermob relies on the **teak expertise of Vlaemynek** (a brand in the Fermob group), and uses the same supplier.

Teak is an exceptional wood; it is used in shipbuilding because of the protection provided by its naturally occurring oleoresin. It is rot-proof, withstands the action of insects, inclement weather and the passing of time. **The king of woods for outdoors**, teak requires no maintenance to keep its technical characteristics: robustness, longevity and ease of use.

The teak we use has come from the same factory for 30 years, sourced exclusively from legal tropical plantations that can ensure the **longevity of the species and protect the environment**.

The teak used by Fermob is:

- Natural: **untreated and un-oiled**. It fades to grey after a year, producing a patina that enhances its authentic feel and contemporary style. It requires no maintenance.
- Grade C: it has knots and other **natural patterns which prevent a uniform appearance**.

Teak showcases Fermob's work on the materials, giving the items of furniture a **warm look and a comfortable feel** (as teak stays cool).



# IMPACT PEOPLE'S MIND

NOT NATURE !

Fermob furniture is designed to live outdoors, and is made using materials and processes that respect the environment. Environmental concerns have always been at the heart of the design and aesthetic qualities of Fermob's creations, together with their lightness and resistance, helping us **save materials** and **limit waste** as well as **transport impact**.

## ECO-DESIGN

### METAL : AN ENVIRONMENTALLY FRIENDLY CHOICE

**Approximately 98% of all iron and aluminium is now recycled worldwide.** This means that Fermob can guarantee that its furniture is fully recyclable – and recycled.

### ECOLOGICAL PAINT THAT PROTECTS BOTH THE ENVIRONMENT AND YOUR HEALTH

The powder paint used by Fermob contains **no solvents**. It is **100% recycled and recyclable** and it is applied in a **zero-waste facility**, with successive dips making our products guaranteed for outdoor use.



**Zero discharge of polluted water** thanks to the use of a carefully balanced successive-dip process in the surface treatment tunnel.



**Zero atmospheric emissions** heat from the ovens is even recovered to heat the metal treatment baths!



**Zero powder waste** our solvent-free, 100% polyester powder coating is applied without water via a closed-loop process, meaning that any surplus powder is collected via suction and reused.

Because this facility is a **classified installation on environmental protection grounds**, Fermob has specific obligations and responsibilities that echo its commitment to the environment. The brand is also part of a program that aims to reduce the release of dangerous substances into water.

### CONTINUALLY IMPROVING OUR ENVIRONMENTAL IMPACT

**Optimising energy consumption** remains one of Fermob's key concerns, as regularly demonstrated through **concrete actions**:

- **Reducing the temperature** of our ovens (-10°C in 25 years),
- Setting up a **stoving process that consumes 10% less energy**,
- Investing in a **new painting line**, saving 8 tons of powder per year,
- **Reduction in our water use** (30% reduction in 5 years),
- **Reduction in our electricity use**, with the addition of LED lighting (5% reduction in 5 years).

## RECYCLED AND RECYCLABLE PACKAGING

For many years, Fermob has been a member of **CITEO**, our **eco-organisation tasked with collecting and sorting packaging**.

We help turn our everyday products into new resources, and we are firm believers in getting the packaging just right—using eco-designed packaging that contains as few raw materials as possible.



In compliance with France's AGEC law of 10 February 2020 (anti-waste law to promote the circular economy), we use the TRIMAN system on our labels to inform consumers of the waste sorting rules concerning our furniture, its packaging and documentation. The TRIMAN logo comes with an information box indicating the sorting or waste disposal instructions for the various elements.



## EXTENDING SERVICE LIFE

Some of the product components can be replaced if they become worn or damaged over time.

Our catalogue includes a range of spare parts: protective pads for chairs and tables, glide pads, cushion covers, etc. (see detailed list in our price list).

## MANAGING END OF LIFE

Fermob has been working with Ecomaison since 2013; this eco-organisation collects and restores used furniture to give it a second life or ensures the recycling of its materials



Ecomaison's missions are to collect and sort used items of furniture, and to meet the recycling and recovery targets set by public authorities. Fermob commits to this process by:

- Upholding a long-standing tradition of creating **eco-designed** products
- **Informing and raising awareness among its consumers** on the use of eco-participation
- **Promoting donation and reuse in partnership** with players from the non-profit sector



# RE-PAINT

GIVE NEW LIFE TO YOUR FURNITURE



Do you have a piece of Fermob furniture that holds special memories for you? Over the years, the colours of our precious Fermob products may fall out of style or show signs wear.

## GIVE NEW LIFE TO YOUR FERMOB FURNITURE, RE-INVENT IT: WE PROPOSE AN INNOVATIVE SOLUTION!

Fermob has joined forces with Axalta, its paint supplier and long-standing partner, to offer a brand-new solution to renovate your Fermob furniture, **via a certified network of galvanisation re-paint professionals. Available in France for now.**

Exclusive partnership with:



### HOW DOES IT WORK?

1. Submit your request online via <https://re-paint.com/renovation-fermob>, selecting your nearest painting renovation professional.
2. Fermob checks the authenticity of the furniture, then sends the request to the re-paint professional who validates the feasibility of the renovation and proposes a quotation.
3. After validation of the quotation, you drop your Fermob furniture off at the premises of the re-paint professional.
4. The re-paint professional renovates your furniture.
5. The carefully-finished result will last for years!

### KEY FIGURES

- More than 160 eligible Fermob products
- A selection of 15 exclusive Fermob colours
- A network of around forty professionals in France, located within 80km of your address.

## Respect of the environment FERMOB STEPS UP ITS COMMITMENTS!

Since the company was founded, **Fermob has naturally strived to protect its environment and create sustainable products:** solvent-free and water-free paint, recyclable materials for its furniture, zero-waste painting process, heat recycling, workstation ergonomics, etc. Our entire manufacturing process complies with the **highest quality standards.**

Today, Fermob takes another step forward, completing its environmental commitments with a **local paint renovation network:** re-paint. Not only does this solution extend the life-time of your Fermob furniture, but being local, it limits the transport involved in the operation and thus **its carbon footprint.** This ambition corresponds perfectly to the challenges of our social responsibility and the changes in our lifestyles.

# THE FERMOB GUARANTEE

## CHARTER

### EUROPEAN FURNITURE GUARANTEE

When we design our products, we pay special attention to three key aspects:

- making sure the piece will continue to fulfil its intended purpose for many years to come
- anticipating how it will age as time passes
- designing it so it is suited to our customers' requirements.

As a manufacturer, we have a duty to guarantee that our products are fit for purpose, no matter how our customers use them.

We never stop listening to our customers. That is why we have amended our European Furniture guarantee to reflect painstaking laboratory testing and customer feedback.

Because we use only the highest-quality materials and finishes, we are now in a position to go one step further and offer two separate guarantees – a **5-year functional guarantee** on all our items of furniture, plus a **2-year ageing guarantee**, provided that the product is used as per our recommendations.



**FUNCTIONAL  
GUARANTEE**  
5 YEARS



**AGEING  
GUARANTEE**  
2 YEARS

Each of our products comes with a recommended usage setting, so you can better cater to your own customers' requirements and keep the guarantee valid:

1. **Domestic:** product designed for private use in non-public spaces such as gardens, winter gardens, patios, terraces and balconies.
2. **Professional:** product designed for professional use in supervised public spaces such as restaurants, outdoor pools, beaches and recreational facilities.
3. **Intensive professional:** mobile product, not fixed to the ground, designed for professional use in unsupervised public spaces such as motorway service stations, public parks and squares that are accessible around the clock.



#### • 5-YEARS FUNCTIONAL GUARANTEE

Fermob guarantees that products will remain fit for the purpose for which they were designed for 5 years. The guarantee covers all functional aspects of the product such as welding, fasteners, rivets and folding.

**If a product is not used as per Fermob's recommendations, the functional guarantee is reduced to 2 years.**

#### • 2-YEARS AGEING GUARANTEE

The speed at which a product ages depends on how carefully it is treated by customers. Please read the exclusions so you can advise customers how to care for and maintain their products.

The ageing guarantee covers premature and abnormal deterioration in the appearance of the product's materials.

**Fermob's 2-year ageing guarantee applies in Europe (excluding Russia) only. Elsewhere, the guarantee is 2 years for aluminium furniture and 1 year for steel furniture.**

## THE AGEING AND FUNCTIONAL GUARANTEES DO NOT COVER:

- Damaged, converted or modified furniture.
- Furniture not used as per Fermob's recommendations.
- Any damage arising from insufficient care, or from failure to comply with the supplied instructions and advice for receiving, assembling, using, maintaining and storing furniture supplied to the customer.
- Rings or stains undeclared when unpacking (including stains related to a combination of humidity retention + heat).
- General wear and tear or natural fading of the materials used.
- Corrosion originating from scratches or abrasions that result from general wear and tear and which cannot be removed via standard cleaning and maintenance processes.
- Minor spots of rust under table tops and seats or on bases. These are a natural outcome of the material used (iron) and can be treated using the maintenance tools made available to customers by Fermob.
- Corrosion of stainless steel parts due to use in a confined, and/or chlorinated environment.
- Corrosion of steel furniture (including stainless steel furniture) as a result of use in a coastal environment.
- Any changes in the visual appearance of wood that are directly linked to ageing. As wood is a living material, the appearance of its surface changes naturally over time.
- Irregularities in the leather are proof of its authenticity
- Patina and ageing may alter the appearance of the leather over time. Leather is a natural, living material whose surface condition evolves over the years.

This guarantee is limited to reimbursement (with application of a reduction) or replacement of the product, and applies only upon presentation of the purchase receipt (cash register slip or purchase invoice).

## EUROPEAN LIGHTING GUARANTEE

Our lamps are subject to the applicable European legal guarantees. They comply with European standards and certifications (e.g. NF EN 62262).

### THE LIGHTING GUARANTEE SPECIFICALLY EXCLUDES THE FOLLOWING:

- Modified or transformed lighting products.
- Lighting products that have been repaired using components not supplied by the brand, or without following the instructions provided by Fermob.
- Lighting products that have been used in a way not recommended by Fermob.

The exclusion conditions concerning changes in the appearance of the wood are the same as those for Fermob furniture (see above).

USE	DOMESTIC	PROFESSIONAL	INTENSIVE
GUARANTEE	2 YEARS	1 YEAR	-

## EUROPEAN PARASOL AND ACCESSORY GUARANTEE

Fermob parasols and accessories (cushions, etc.), like our furniture, are designed to last being made from carefully selected materials. They are guaranteed according to European legal conditions.

- Acrylic and PVC textiles are guaranteed against UV, abrasion, mould and tearing.
- Reticulate foam fillings are guaranteed against mould.

### THE PARASOL AND ACCESSORY GUARANTEES SPECIFICALLY EXCLUDE THE FOLLOWING:

- Modified or transformed parasols or accessories.

### THE LIGHTING, PARASOL AND ACCESSORY GUARANTEES SPECIFICALLY EXCLUDE THE FOLLOWING:

- Deterioration due to lack of due care or non-compliance with user instructions for maintenance and storage (for example, closing the parasol during bad weather).
- Marks or stains not declared on unpacking.
- Natural wear and fading of materials used.
- Start of corrosion due to scratches or abrasions caused by use, which cannot be eliminated by normal cleaning and maintenance.
- The exclusion conditions applicable to Fermob furniture also apply to the metal components of lighting products, parasols & accessories (see above).

These guarantees are limited to refunds (on condition that a usage discount is applied) or replacement of the product, and only apply on presentation of proof of purchase (receipt or invoice for the purchase).

For intense use of a light, parasol or product accessory, please contact our sales department, whose teams will provide you with all the information necessary for this type of use.

**For all countries outside the European Union, the country's own legal guarantee will apply.**

USE	DOMESTIC	PROFESSIONAL	INTENSIVE
GUARANTEE	2 YEARS	1 YEAR	-

**NEW COLOURS**



**GINGERBREAD**





**PESTO**

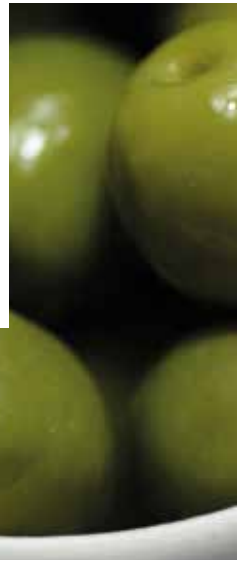

# MARSHMALLOW

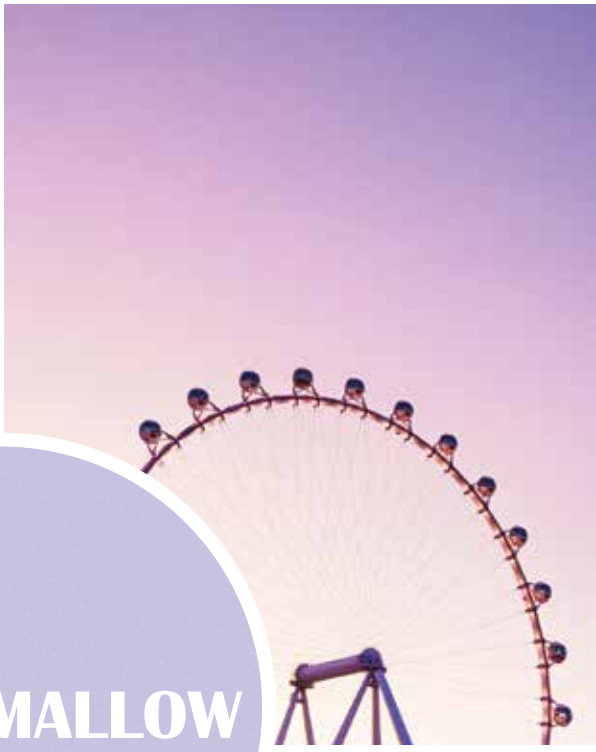

# COLOUR COMBINATIONS

OUR ADVICE



<p><b>CLAY GREY</b></p> <p>COTTON WHITE   HONEY</p> <p>LAPILLI GREY   CAPUCINE</p>	<p><b>LAPILLI GREY</b></p> <p>BLACK CHERRY   CACTUS</p> <p>PESTO   FROSTED LEMON</p>	<p><b>STORM GREY</b></p> <p>GINGERBREAD   LIQUORICE</p> <p>CACTUS   CLAY GREY</p>	<p><b>ANTHRACITE</b></p> <p>RED OCHRE   LAPILLI GREY</p> <p>CLAY GREY   ROSEMARY</p>
<p><b>RED OCHRE</b></p> <p>PESTO   FROSTED LEMON</p> <p>WILLOW GREEN   BLACK CHERRY</p>	<p><b>BLACK CHERRY</b></p> <p>RED OCHRE   GINGERBREAD</p> <p>HONEY   PESTO</p>	<p><b>NUTMEG</b></p> <p>FROSTED LEMON   GINGERBREAD</p> <p>WILLOW GREEN   RED OCHRE</p>	<p><b>GINGERBREAD</b></p> <p>MARSHMALLOW   CLAY GREY</p> <p>OPALINE GREEN   ROSEMARY</p>



**CHILI**

RED OCHRE CEDAR GREEN  
NUTMEG BLACK CHERRY

**POPPY**

CHILI RED OCHRE  
RED OCHRE BLACK CHERRY

**CAPUCINE**

FROSTED LEMON GINGERBREAD  
ICE MINT CHILI

**HONEY**

FROSTED LEMON GINGERBREAD  
WILLOW GREEN BLACK CHERRY

**LIQUORICE**

CLAY GREY STORM GREY  
NUTMEG LAPILLI GREY

**DEEP BLUE**

ANTHRACITE MARSHMALLOW  
CLAY GREY ACAPULCO BLUE

**ACAPULCO BLUE**

ICE MINT CEDAR GREEN  
MARSHMALLOW PESTO

**CEDAR GREEN**

PESTO CACTUS  
WILLOW GREEN OPALINE GREEN

**PESTO**

FROSTED LEMON CLAY GREY  
MARSHMALLOW WILLOW GREEN

**WILLOW GREEN**

BLACK CHERRY FROSTED LEMON  
RED OCHRE GINGERBREAD

**CACTUS**

WILLOW GREEN PESTO  
CAPUCINE ROSEMARY

**ROSEMARY**

ACAPULCO BLUE COTTON WHITE  
DEEP BLUE CLAY GREY

**FROSTED LEMON**

ICE MINT GINGERBREAD  
MARSHMALLOW PESTO

**ICE MINT**

MARSHMALLOW CLAY GREY  
WILLOW GREEN CEDAR GREEN

**OPALINE GREEN**

COTTON WHITE DEEP BLUE  
ICE MINT ACAPULCO BLUE

**MARSHMALLOW**

ICE MINT ROSEMARY  
ACAPULCO BLUE FROSTED LEMON

STOOLS

ACCESSORISE YOUR SEATS :

STACKING



LUXEMBOURG®  
4111  
**P.119**



MONCEAU  
4805  
**P.134**

OTHERS



COCOTTE  
4702  
**P.96**



PIAPOLO  
3206  
**P.149**



CHAIRS

STACKING



1900  
2201  
**P.36**



ANGE  
2008  
**P.46**



CADIZ  
8701  
**P.88**



FACTO  
2501  
**P.22**



KINTBURY  
5810  
**P.111**



LORETTE  
5711  
**P.114**



LOUVRE  
0801  
**P.118**



LUXEMBOURG®  
4101  
**P.119**



LUXEMBOURG® STEEL  
4121  
**P.131**



MONTMARTRE  
4601  
**P.138**



OPÉRA+  
0911  
**P.141**



SIXTIES  
1702  
**P.159**



STRIPE  
3260  
**P.165**



STUDIE  
6911  
**P.166**



STUDIE  
6921  
**P.167**



SURPRISING  
1225  
**P.168**



SURPRISING TEAK  
1241  
**P.168**

FOLDING



BISTRO METAL  
0101  
**P.77**



BISTRO VALET  
0105  
**P.78**



BISTRO CLASSIC  
5001  
**P.78**



BISTRO DURAFLO®  
6301  
**P.78**



BISTRO NATURAL  
5107  
**P.79**



BISTRO LEATHER  
0102  
**P.79**



DUNE PREMIUM  
1201  
**P.103**



LA MÔME  
3701  
**P.112**



LATITUDE  
4911  
**P.113**



PLEIN AIR  
8301  
**P.151**

OTHERS



BELLEVIE  
8402  
**P.55**



SIXTIES  
1701  
**P.159**



STACKING



1900  
2202  
**P.36**



AIRLOOP  
7312  
**P.41**



CADIZ  
8702  
**P.88**



KATE  
7302  
**P.110**



LORETTE  
5712  
**P.114**



LOUVRE  
0802  
**P.118**



LUXEMBOURG®  
4102  
**P.119**



LUXEMBOURG® STEEL  
4122  
**P.131**



MONCEAU ARMCHAIR  
4803  
**P.134**



MONCEAU XL ARMCHAIR  
4802  
**P.134**



MONTMARTRE  
4602  
**P.138**



OPÉRA+  
0912  
**P.141**



RYTHMIC  
4402  
**P.157**



STUDIE  
6912  
**P.166**



STUDIE OAK  
6922  
**P.167**

NEW

FOLDING



DUNE PREMIUM  
1202  
**P.103**



PLEIN AIR  
8303  
**P.151**

OTHERS



BELLEVIE  
8405  
**P.55**

ACCESSORISE YOUR SEATS :



BASICS / COLOR MIX  
ROUND CUSHIONS  
**P.183/188**



BASICS  
CUSHIONS  
**P.183**



BASICS GALETTE  
SKIN  
**P.184**



COLOR MIX CUSHION  
41 X 38  
**P.188**

BENCHES

2/3 PEOPLE



1900  
2204  
**P.38**



CROISSETTE  
1805  
**P.100**



BISTRO  
0104  
**P.77**



LORETTE  
5714  
**P.116**



LUXEMBOURG®  
4114  
**P.120**

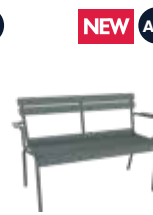

LUXEMBOURG®  
4116  
**P.128**



LUXEMBOURG®  
4115  
**P.120**



MONCEAU  
4810  
**P.135**



SIXTIES  
1705  
**P.160**

3 PEOPLE +



BELLEVIE  
8410  
**P.56**



BELLEVIE BACKREST  
8415  
**P.56**



BELLEVIE PREMIUM  
8418  
**P.75**



CHARIVARI  
1025  
**P.95**

## BENCHES

3 PEOPLE & +



CROISSETTE  
1806  
**P.100**



LOUISIANE  
1000  
**P.117**



LOUISIANE  
1001  
**P.117**



LUXEMBOURG®  
4110  
**P.120**



MONCEAU  
4811  
**P.135**



SOMERSET  
3237  
**P.163**

ACCESSORISE YOUR BENCHES :



NEW



BOUQUET SAUVAGE  
CUSHIONS  
**P.186**

NEW



COLOR MIX  
CUSHIONS  
**P.192**



COLOR MIX  
OUTDOOR BENCH CUSHIONS  
**P.190**



ÉVASION  
CUSHIONS  
**P.194**



LORETTE  
CUSHIONS  
**P.198**



TRÈFLE  
CUSHIONS  
**P.200**

## LOUNGE PIECES

STACKING



ALIZÉ  
8907  
**P.45**



CADIZ  
8704  
**P.88**



CROISSETTE  
1804  
**P.100**



LUXEMBOURG®  
4211  
**P.126**



LUXEMBOURG®  
4212  
**P.126**



LUXEMBOURG®  
4104  
**P.128**



LUXEMBOURG®  
ACIER 4124  
**P.131**



LUXEMBOURG®  
4105  
**P.128**



MONCEAU  
4804  
**P.137**

OTHERS



1900  
2205  
**P.37**



LORETTE  
5713  
**P.116**



SIXTIES  
1704  
**P.159**



SURPRISING  
1217  
**P.169**



SURPRISING  
TEAK 1244  
**P.169**



SURPRISING  
CUIR 1260  
**P.171**

ROCKING-CHAIR



LUXEMBOURG®  
4166  
**P.126**



MONCEAU  
4806  
**P.137**



SIXTIES  
1706  
**P.159**



SURPRISING  
1228  
**P.170**

FOOTRESTS



ALIZÉ  
8918  
**P.45**



LUXEMBOURG®  
4160  
**P.130**



MONCEAU  
4840  
**P.137**



SURPRISING  
1218  
**P.169**



SURPRISING  
TEAK 1245  
**P.169**



SURPRISING  
LEATHER 1261  
**P.171**

NEW

ACCESSORISE YOUR LOUNGE SEATS :



BASICS CUSHION  
96 X 47 CM  
**P.183**



COLOR MIX  
SET OF 2 CUSHIONS  
**P.190**

UPHOLSTERED FURNITURE



BELLEVIE 8490 **P.61**    BELLEVIE 8494 **P.61**    BELLEVIE 8440 **P.61**    BELLEVIE 8445 **P.61**    BELLEVIE 8480 **P.62**    BELLEVIE 8525 **P.62**    BELLEVIE 8530 **P.62**



**NEW** **ALL** SOMERSET 3232 **P.163**    **NEW** **ALL** SOMERSET 3235 **P.163**

MODULAR PIECES



BELLEVIE 8510 **P.65**    BELLEVIE 8520 **P.65**    BELLEVIE 8512 **P.64**    BELLEVIE 8522 **P.64**    BELLEVIE 8511 **P.64**    BELLEVIE 8521 **P.64**    BELLEVIE 8540 **P.65**



BELLEVIE 8524 **P.66**    BELLEVIE 8523 **P.65**    BELLEVIE 8409 **P.66**    BELLEVIE 8452 **P.66**    BELLEVIE 1A/1B 8580 / 8581 **P.68**    BELLEVIE 2 8588XXYY **P.68**    BELLEVIE 3A/3B 8586XXYY / 8587XXYY **P.69**

COMPOSITIONS

ACCESSORISE YOUR CUSHIONED LOUNGE FURNITURE :



COVERS **P.73 & 74**

**NEW** BOUQUET SAUVAGE CUSHIONS **P.186**    **NEW** COLOR MIX CUSHIONS **P.192**    ÉVASION CUSHIONS **P.194**    LORETTE CUSHIONS **P.198**    TRÈFLE CUSHIONS **P.200**

LOW TABLES



1900 2233 **P.38**    ALIZÉ 8960 **P.45**    ALIZÉ 8961 **P.45**    BEBOP 5627 **P.50**    BEBOP 5610 **P.50**    BEBOP 5613 **P.50**    BEBOP 5616 **P.50**

BEBOP 5622 **P.48**    BEBOP 5626 **P.48**    BEBOP 5628 **P.48**    BELLEVIE 8450 **P.71**    BELLEVIE 8453 **P.71**    COCOTTE 4703 **P.96**    COCOTTE 4720 **P.96**    CROISSETTE 1820 **P.100**

## LOUNGE PIECES



LORETTE  
5740  
**P.116**

LUXEMBOURG®  
4161  
**P.130**

LUXEMBOURG®  
4168  
**P.130**

LUXEMBOURG®  
4169  
**P.130**

MONCEAU  
4841  
**P.137**

OULALA  
9009  
**P.144**

SALSA  
3271  
**P.158**

SIXTIES  
1721  
**P.160**



ULTRASOFA  
6250  
**P.173**

MID-HEIGHT  
TABLES



BELLEVIE  
8459  
**P.71**



BELLEVIE  
8457  
**P.71**

ACCESSORISE DINING AND LOUNGE TABLES:

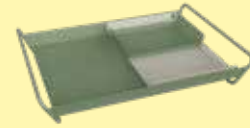

ALTO  
TRAY  
**P.182**

## SIDE BARS



ALFRED  
3240  
**P.42**



GUINGUETTE  
1061 & 1062  
**P.108**



LUXEMBOURG®  
4164  
**P.120**



MONTMARTRE  
1060  
**P.138**



QUIBERON  
3210  
**P.152**



SALSA  
3270  
**P.158**

## SUNLOUNGERS

STACKING



ALIZÉ  
8906  
**P.43**



ALIZÉ XS  
8911  
**P.44**

FOLDING



BISTRO  
1601  
**P.80**



DUNE  
1308  
**P.102**

OTHERS



BELLEVIE  
8502  
**P.72**

ACCESSORISE SUNLOUNGERS:



COVERS  
**P.251**



BASICS 171 X 44 CM  
**P.184**



BELLEVIE HEADREST  
**P.72**



COLOR MIX HEADREST  
**P.190**

NEW



COLOR MIX FOUTA  
**P.193**

## CHILDREN'S PIECES

SEATS



LUXEMBOURG®KID  
4106  
**P.133**



LUXEMBOURG®KID  
4109  
**P.133**

TABLES



LUXEMBOURG®KID  
4170  
**P.133**



LUXEMBOURG®KID  
4171  
**P.133**

OTHERS



ADADA  
3280  
**P.39**

SEATS



BELLEVIE  
8403  
**P.59**

BISTRO  
5113  
**P.80**

CADIZ  
8703  
**P.89**

CADIZ  
8705  
**P.89**

FACTO  
2503  
**P.105**

LUXEMBOURG®  
4112  
**P.124**

LUXEMBOURG®  
4103  
**P.124**



LUXEMBOURG®  
4113  
**P.124**

ACCESSORISE SEATS:



TABLES



BELLEVIE  
8467  
**P.59**

BELLEVIE  
8464  
**P.59**

BISTRO  
0250  
**P.80**

CALVI  
8750  
**P.91**

LUXEMBOURG®  
4140  
**P.124**

LUXEMBOURG®  
4141  
**P.125**

TABLES

2 - 5 people

FOLDING



BISTRO  
6034  
**P.83**

BISTRO  
6042  
**P.81**

BISTRO  
0244  
**P.81**

BISTRO  
0243  
**P.83**

BISTRO  
0239  
**P.83**

BISTRO  
0245  
**P.84**

BISTRO  
0233  
**P.84**



BISTRO  
0235  
**P.84**

BISTRO  
0270  
**P.81**

BISTRO+  
0212  
**P.85**

BISTRO+  
0210  
**P.85**

FLORÉAL  
0230  
**P.106**

FLORÉAL  
0234  
**P.106**

FLORÉAL  
0236  
**P.106**



KALAHARI  
3267  
**P.118**

FOLD-DOWN



PÉTALE  
7238  
**P.148**

PÉTALE  
7237  
**P.148**

REST'O  
8810  
**P.153**

REST'O  
8813  
**P.153**

TABLES

2 - 5 people

NON-FOLDING



1900  
2240  
**P.36**



AIRLOOP  
7320  
**P.41**



BELLEVIE  
8428  
**P.56**



BELLEVIE  
8425  
**P.56**



ALU

COSTA  
8143  
**P.98**



FLOWER  
7110  
**P.106**



ALU

LUXEMBOURG®  
4134  
**P.122**



ALU

LUXEMBOURG®  
4142  
**P.122**



ALU

LUXEMBOURG®  
4135  
**P.122**



MONTMARTRE  
0630  
**P.139**



OPÉRA+  
0949  
**P.141**



OPÉRA+  
0948  
**P.141**



OPÉRA+  
0946  
**P.142**

6 - 10 people

FOLDING



BISTRO  
0240  
**P.83**



BISTRO  
0237  
**P.84**



CARACTÈRE  
5932  
**P.92**



CARACTÈRE  
5930  
**P.92**



CARACTÈRE  
5933  
**P.92**



CARACTÈRE  
5931  
**P.92**



CARGO  
0241  
**P.94**



CARGO  
0248  
**P.94**



CARGO  
0247  
**P.94**

NON-FOLDING



1900  
2241  
**P.36**



ALU

BELLEVIE  
8420  
**P.57**



ALU

BELLEVIE  
8434  
**P.57**



BELLEVIE PREMIUM  
8432  
**P.75**



ALU

CALVI  
8753  
**P.91**



ALU

CALVI  
8744  
**P.91**



ALU

CALVI  
8740  
**P.91**



ALU

COSTA  
8160  
**P.98**



CRAFT  
1970  
**P.99**



LORETTE  
5761  
**P.114**



LORETTE  
5762  
**P.114**



ALU

LUXEMBOURG®  
4133  
**P.122**



ALU

LUXEMBOURG®  
4136  
**P.123**



ALU

LUXEMBOURG®  
4132  
**P.123**



MONCEAU  
4831  
**P.135**



MONCEAU  
4832  
**P.135**



MONTMARTRE  
0631  
**P.139**



OPÉRA+  
0950  
**P.142**



OPÉRA+  
0947  
**P.142**



TABLES

6 - 10 people



ROMANE  
2131  
**R.156**

ROMANE  
2134  
**R.156**

**NEW**  
SO'O  
3261  
**R.164**

WITH EXTENSIONS

**ALLU**  
COSTA  
8147  
**R.98**

**ALLU**  
RIBAMBELLE  
5221  
**R.154**

11+ people

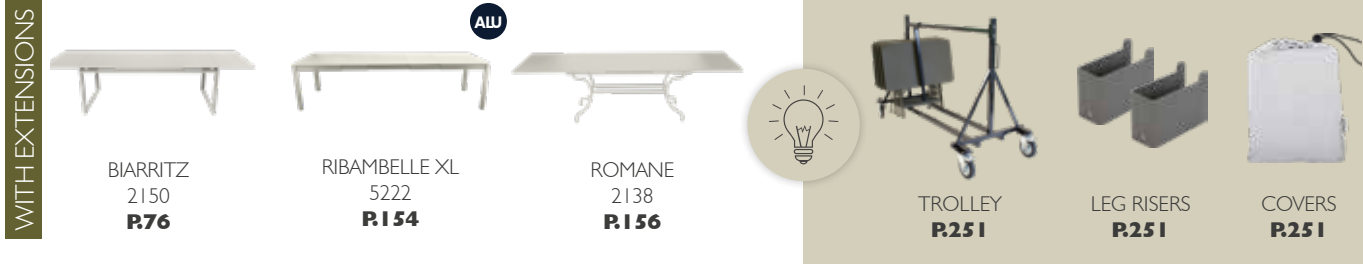

BIARRITZ  
2150  
**R.76**

RIBAMBELLE XL  
5222  
**R.154**

ROMANE  
2138  
**R.156**



TROLLEY  
**R.251**

LEG RISERS  
**R.251**

COVERS  
**R.251**

ACCESSORISE YOUR TABLES :

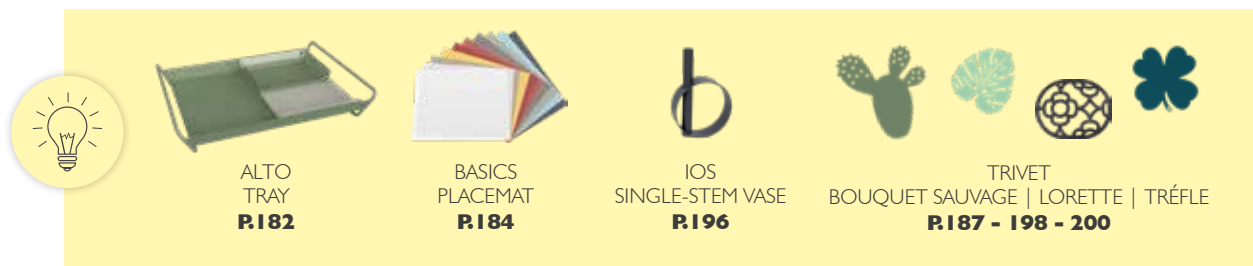

ALTO  
TRAY  
**R.182**

BASICS  
PLACEMAT  
**R.184**

IOS  
SINGLE-STEM VASE  
**R.196**

TRIVET  
BOUQUET SAUVAGE | LORETTE | TRÉFLE  
**R.187 - 198 - 200**

OTHER PRODUCTS



PLANTERS

BASKET  
3231  
**R.47**

BASKET  
3230  
**R.47**

TERRAZZA  
3251  
**R.172**

TERRAZZA  
3250  
**R.172**

PLANT HOLDER

**NEW**  
PICOLINO  
3249  
**R.150**

AROUND THE FIRE

NEVADO LOG HOLDER  
3219  
**R.140**

OTHERS

ACCROCHE COEURS  
9690  
**R.180**

ACROBATE  
9693  
**R.181**

FACE À FACE  
3209  
**R.104**

**NEW**  
PICOLINO  
3281  
**R.150**

**ALLU**  
PASAIA SHOWER  
3200  
**R.147**

PARASOL & BASE

SHADOO  
8010  
**R.168**

BASICS  
8090  
**R.168**



ADADESK  
3279  
**P.40 & 245**



BOLDER  
1050  
**P.86 & 246**



BOLDER  
1053  
**P.86 & 246**



BOLDER  
1057  
**P.87 & 248**



BOLDER  
1058  
**P.87 & 248**



BOLDER  
1047  
**P.87 & 248**



KALAHARI  
3267  
**P.109 & 250**



LUXEMBOURG®  
WORK 4143  
**P.132 & 250**

PORTABLE LAMPS



APLÔ 3410 **P210**    BALAD 3602 **P214**    BALAD 3612 **P214**    BALAD 3622 **P215**    BALAD BAMBOO 365100 **P218**    BALAD BAMBOO 365200 **P218**    BALAD BAMBOO 365300 **P219**    ULLI 3810 **P237** **NEW**

TABLE LAMPS



APLÔ 3450 **P212**    MOON! 5303 **P228**    MOON! 5304 **P228** **NEW**    OTO 3960 **P235** **NEW**    HOOPIK 3510 **P224** **NEW**

FLOOR LAMPS



BALAD 3632 **P216**    BALAD 3631 **P216**    BALAD 3630 **P216**    PIED SIMPLE 3480 **P212** **NEW**    MOON! 5320 **P230**    MOON! 5310 **P231**

WALL LIGHTS



APLÔ 3460 **P212**    MOON! 5330 **P232**

PENDANT LIGHTS & STRING LIGHTS



APLÔ 3470 **P212**    HOOPIK 3501/3503 **P222**    MOON! 5350 **P234** **NEW**    MOON! 5340 **P234** **NEW**

ILLUMINATED FURNITURE



INOUI 3304 **P226**

To turn your smart lights on remotely

LUDO 3390 **P227**    APPLICATION FERMOB LIGHTING **P221**

BASKET, COCOTE, DUNE, SHADOO, ACCROCHE-COEURS, COLOR MIX & LORETTA





# THE FURNITURE COLLECTIONS

## SYMBOLS

### RECOMMENDED USAGE



### IPAC

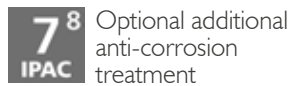

### MARKET



### COLOURS



### PRODUCT INFORMATION



New products in development.  
More accurate information coming soon.

### FURNITURE SPECIFICITIES



Product for indoor use only



Requires assembly



Removable tray



Folding



Fold-away tops



Stacking



Adjustable



Extending



Right armrest



Left armrest



No. of guests max.



Product fitted with silencing pads

### FABRICS CHARACTERISTICS



Water repellent fabric



Machine washable at 30°C



Removable covers



Brush the fabric if there are stains or other marks

## SEAT HEIGHT

### LOUNGE :

Armchair, sofa and mid-height table

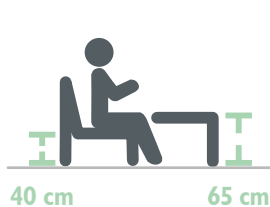

### DINING :

Standard seat and table

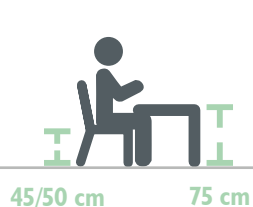

### HIGH DINING :

Bar stool, bar chair, high armchair and high table

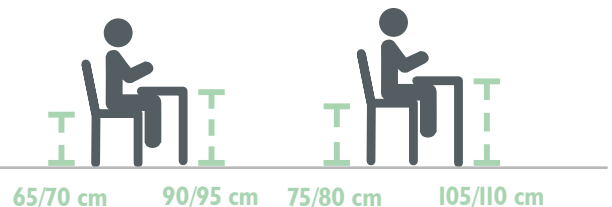

## GLOSSARY

### ACRYLIC

Synthetic fibre that is soft and silky to the touch, does not pill, and is ultra-light.

- extremely resistant to tearing and wear
- rotproof (i.e. prevents the formation of mould)
- keeps its shape
- UV and fade resistant
- does not retain heat or moisture
- resistant to temperature variations (-30° to +70°C)
- resistant to chemicals
- easy to clean: machine-washable at 30°C, no ironing required.

All our acrylic fabrics are water-repellent.

### CAST IRON

Cast iron is a carbon-rich iron alloy. Its density, weight and sturdiness mean that it is ideally suited for stability purposes.

### COATING

A treatment process in which a coating is applied to the surface of a textile to make it waterproof.

### SOLUTION-DYED

Fermob uses solution-dyed textiles (the dye is applied to the fibre, not the surface). This dyeing technique means that the colour lasts five times longer than a conventional dye.

### STAINLESS STEEL

Stainless steel is an alloy of steel and chromium that is highly resistant to corrosion and rust. Fermob uses stainless steel to make the screws for its products.

### SILENCING PADS



An exclusive, patented technology that allows furniture to slide effortlessly across the floor and features an integrated shock absorber to reduce vibrations. Comes as standard on Croisette, Facto, Kate, Luxembourg®, Luxembourg® Kid table, Monceau, Pétale, Rythmic, Salsa, Stripe and Studie.

NOISE REDUCTION OF 14 DB = 10 TIMES QUIETER!

### WATER-RESISTANT

Offers long-lasting protection against moisture.

# 1900

2201 - CHAIR

DOMESTIC PROFESSIONAL INTENSIVE 7 IPAC 25



Steel wire frame  
 Perforated steel sheet seat  
 Steel wire backrest  
 Hand forged scrolls and rings  
Stacking capacity : x 10 (Height – stacked : 175 cm)  
Compatible with :  
 OUTDOOR CUSHION Ø 39 CM - BASICS  
 OUTDOOR CUSHION Ø 40 CM - COLOR MIX

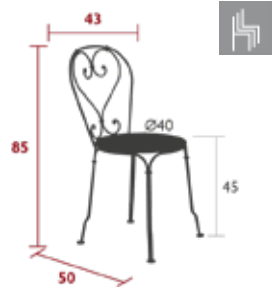

6 kg

2202 - ARMCHAIR

DOMESTIC PROFESSIONAL INTENSIVE 7 IPAC 25



Steel wire frame  
 Perforated steel sheet seat  
 Steel wire backrest  
 Steel wire armrests  
 Hand-forged scrolls, armrests and rings  
Stacking capacity : x 4 (Height – stacked : 122 cm)  
Compatible with :  
 OUTDOOR CUSHION Ø 43 CM - BASICS

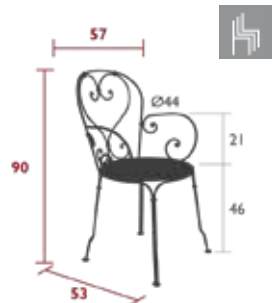

7 kg

2240 - TABLE Ø 96 CM

DOMESTIC PROFESSIONAL INTENSIVE 7 IPAC 25



Perforated steel sheet table top  
 Steel wire base  
 Parasol hole : pole max. Ø 39 mm  
 Hand forged rings



15 kg

2241 - TABLE Ø 117 CM

DOMESTIC PROFESSIONAL INTENSIVE 7 IPAC 25



Perforated steel sheet table top  
 Steel wire base  
 Parasol hole : pole max. Ø 39 mm  
 Hand forged rings



19 kg



# 1900

2205XXYY - CABRIOLET ARMCHAIR



Steel wire frame  
 Perforated steel sheet seat  
 Steel wire backrest  
 Hand forged scrolls and rings  
 Sunbrella® solution-dyed acrylic outdoor fabric  
 Non-slip padding

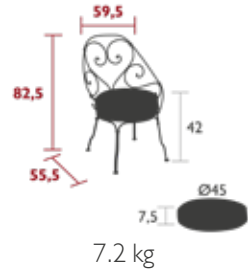

## CUSHION COVERS DESIGNED FOR OUTDOOR USE



COLOUR-FAST  
IN THE SUN



WATER-REPELLENT  
TREATMENT



BREATHABLE :  
QUICK-DRYING



ANTI-STAIN AND  
MOULD  
TREATMENT



TEARPROOF  
AND RESISTANT TO  
ABRASION



REMOVABLE  
COVERS



MACHINE  
WASHABLE

### FILLING :

- High-resilience polyurethane foam : Density 30 kg/m<sup>3</sup> | Thickness 75 mm
- Comfort padding : Thickness 25 mm



Cushion must be brought inside during bad weather

- Fabrics available in 4 colours :

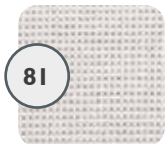

### Off-White

Recommended with frame in :

81



### Flannel Grey

Recommended with frame in :

79

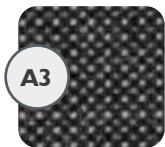

### Graphite Grey

Recommended with frame in :

A3

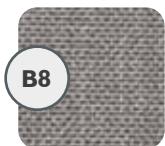

### Grey Taupe

Recommended with frame in :

B8



## SPECIFY THE FRAME AND CUSHION COLOURS WHEN PLACING YOUR ORDER : 220582A3

CABRIOLET ARMCHAIR  
item code 4 numbers

**2205**

CACTUS  
metal colour code XX

**82**

GRAPHITE GREY CUSHIONS  
fabric colour code YY

**A3**

# 1900

2204 - BENCH

DOMESTIC PROFESSIONAL INTENSIVE

7 IPAC



Steel wire frame  
Perforated steel sheet seat  
Steel wire backrest  
Steel wire armrests  
Hand-forged scrolls, armrests and rings  
Stacking capacity : x 2 (Height – stacked : 103 cm)

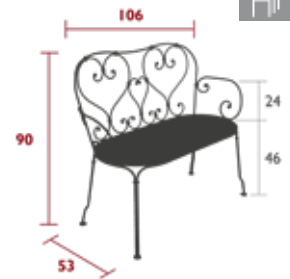

12.8 kg

2233 - LOW TABLE Ø 45 CM

DOMESTIC PROFESSIONAL INTENSIVE

7 IPAC



Perforated steel sheet table top  
Steel wire base  
Hand-forged rings

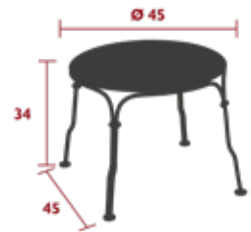

4 kg



# ADADA

3280 - ROCKING HORSE  
DESIGN BY STUDIO FERMOB

DOMESTIC | PROFESSIONAL | INTENSIVE

10  
IPAC



Tubular aluminium frame  
Curved aluminium sheet seat  
PVC pads  
Suitable for children over 10 months old  
Meets toy safety standards (71-1, 71-2, and 71-3)



2.5 kg



ADADA & LUXEMBOURG KID

FURNITURE

3279 - ROCKING DESK  
DESIGN BY STUDIO FERMOB

NEW

DOMESTIC PROFESSIONAL INTENSIVE

10 IPAC



Aluminium tubular frame  
Curved aluminium slats seat  
Aluminium sheet top



4.3 kg

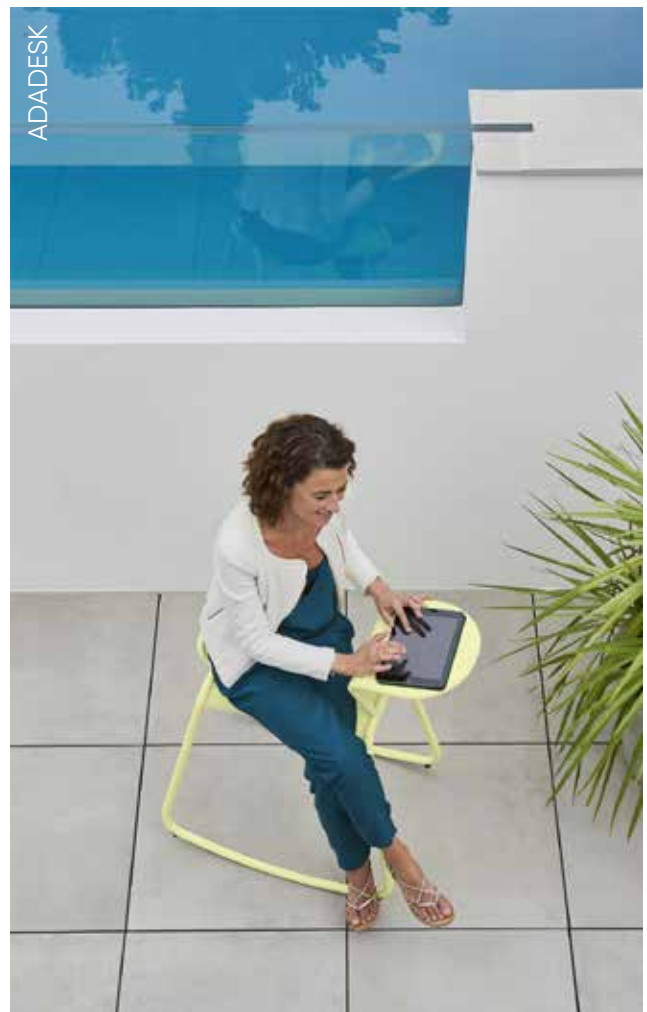

# AIRLOOP

7312 - ARMCHAIR  
DESIGN BY FRÉDÉRIC SOFIA

DOMESTIC PROFESSIONAL INTENSIVE 6<sup>7</sup> IPAC 25



Steel wire frame  
Steel sheet seat  
Steel wire backrest  
Steel wire armrests  
Hand forged rings  
Stacking capacity : x 10 (Height – stacked : 105 cm)  
Compatible with :  
OUTDOOR CUSHION Ø 39 CM - BASICS  
OUTDOOR CUSHION Ø 40 CM - COLOR MIX



5.7 kg

7320 - TABLE Ø 60 CM  
DESIGN BY FRÉDÉRIC SOFIA

DOMESTIC PROFESSIONAL INTENSIVE 6<sup>8</sup> IPAC 25



Steel sheet table top  
Steel wire base  
Hand forged ring  
Reinforced parts:  
Table top (thickness: 1,2 mm)  
No rim, reduces corrosion risk



5.6 kg



AIRLOOP



# ALFRED

3240 - SIDE TABLE  
DESIGN BY PASCAL MOURGUE

DOMESTIC PROFESSIONAL INTENSIVE

6 IPAC



Tubular steel frame  
Steel sheet table top  
Integrated wheels



7.3 kg



# ALIZÉ

8906 - SUNLOUNGER  
 DESIGN BY PASCAL MOURGUE



Tubular aluminium frame  
 Duo or Stereo OTF Batyline® outdoor fabric bed - high-tenacity  
 100% polyester thread coated in solution-dyed PVC  
 Adjustable backrest 5 positions (0°-20°-30°-38°-45°)  
 Adjustable footrest 2 positions (0° - 7°)  
 Zero gravity position available  
 Adjustment system : stainless steel wire  
 Stacking capacity : x 15 (Height – stacked : 141 cm)  
 Available colours: see limited colour chart  
 Compatible with :  
 PROTECTIVE COVER FOR SUNLOUNGERS - ALIZÉ  
 HEADREST 44 X 15 X 5.5 CM - COLOR MIX

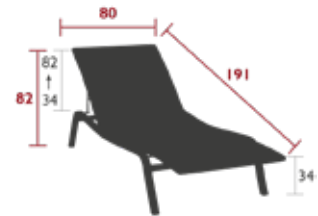

13.5 kg

The **“zero-gravity” position**, as found on the Alizé sunlounger, is **perfect for relaxing** and is widely recommended by medical professionals.

It is this position, with the legs positioned slightly above the heart, that the body adopts in a weightless state. The position was named by NASA in the 1970s. The sensation of gravity is reduced seven-fold, similar to when the body is floating in water.

The legs are raised and the thighs and trunk form an angle of 127 degrees, thereby :

- Significantly easing pressure on the lower back and spine.
- Reducing tension in the lower back muscles.
- Promoting improved blood flow in the legs and reducing strain on the heart.
- Freeing up the rib cage and allowing the lungs to expand, which improves oxygenation.

**Zero gravity is reached by raising the feet (7°) and raising the backrest to the maximum (45°).**

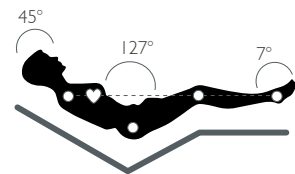

ALIZE, CROISSETTE, MOONNI, ÉVASION & LORETTA

# ALIZÉ

8911 - XS SUNLOUNGER  
DESIGN BY PASCAL MOURGUE

DOMESTIC PROFESSIONAL INTENSIVE

10  
IPAC



Tubular aluminium frame  
Duo or Stereo OTF Batyline® outdoor fabric bed - high-tenacity 100% polyester thread coated in solution-dyed PVC  
Adjustable backrest 3 positions (0°-30°-45°)  
Adjustment system : painted steel wire  
Fixed footrest  
Stacking capacity : x 15 (Height – stacked : 141 cm)  
Available colours: see limited colour chart  
Compatible with :  
PROTECTIVE COVER FOR SUNLOUNGERS - ALIZÉ  
HEADREST 44 X 15 X 5.5 CM - COLOR MIX

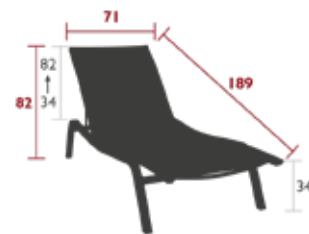

12 kg

8970 - PROTECTIVE COVER FOR SUNLOUNGERS



Tissu outdoor polyester  
Storage capacity: 2-5 sunloungers  
Ties to hold the cover in place  
Do not use as a winter cover  
Compatible with :  
XS SUNLOUNGER - ALIZÉ  
SUNLOUNGER - ALIZÉ

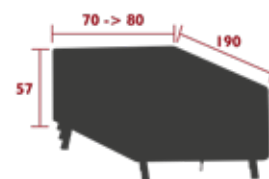

897054  Grey

0.6 kg



ALIZE & OULALA



ALIZE



# ALIZÉ

8907 - LOW ARMCHAIR  
DESIGN BY PASCAL MOURGUE

DOMESTIC PROFESSIONAL INTENSIVE 10 IPAC



Tubular aluminium frame  
Duo or Stereo OTF Batyline® outdoor fabric seat - high-tenacity  
100% polyester thread coated in solution-dyed PVC  
Duo or Stereo OTF Batyline® outdoor fabric backrest - high-tenacity  
100% polyester thread coated in solution-dyed PVC  
Tubular aluminium armrests  
Adjustable backrest 2 positions (114°-125°)  
Adjustment system : stainless steel wire  
Stacking capacity : x 10 (Height – stacked : 161 cm)  
Available colours: see limited colour chart  
Compatible with :  
FOOTREST - ALIZÉ

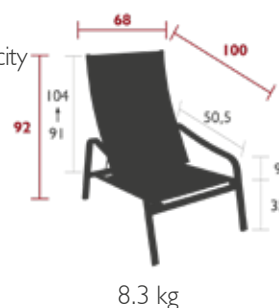

8918 - FOOTREST  
DESIGN BY PASCAL MOURGUE

DOMESTIC PROFESSIONAL INTENSIVE 10 IPAC



Duo or Stereo OTF Batyline® outdoor fabric - high-tenacity  
100% polyester thread coated in solution-dyed PVC  
Tubular aluminium base  
Can be stored under the low armchair  
Available colours: see limited colour chart  
Compatible with :  
LOW ARMCHAIR - ALIZÉ

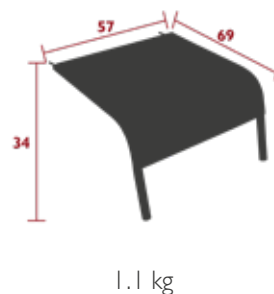

8960 - LOW TABLE Ø 48 CM  
DESIGN BY PASCAL MOURGUE

DOMESTIC PROFESSIONAL INTENSIVE 10 IPAC



Aluminium sheet table top  
Tubular aluminium base  
Stacking capacity : x 20 (Height – stacked : 116 cm)



8961 - OFFSET LOW TABLE Ø 48 CM  
DESIGN BY PASCAL MOURGUE

DOMESTIC PROFESSIONAL INTENSIVE 10 IPAC



Aluminium sheet table top  
Tubular aluminium base

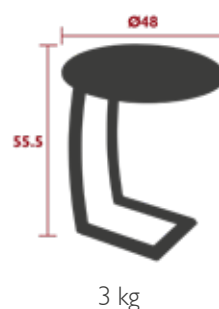

# ANGE

2008 - CHAIR

DESIGN BY JEAN-CHARLES DE CASTELBAJAC

DOMESTIC PROFESSIONAL INTENSIVE

7  
IPAC



Steel wire frame  
Perforated steel sheet seat  
Steel wire backrest  
Steel wire armrests  
Hand-forged wings and rings  
Stacking capacity : x 3 (Height – stacked : 135 cm)

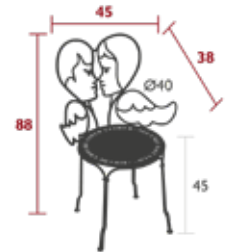

7 kg



ANGE

# BASKET

3231 - HIGH PLANTER  
DESIGN BY FABIO MELIOTA



Steel wire frame  
Steel wire handle  
Aluminium tray  
2 drainage holes at each end of the tray, with plugs  
Feet and tray separable

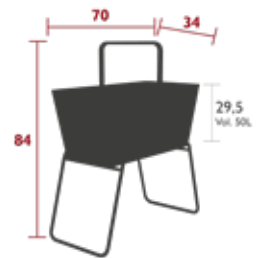

12.5 kg

3230 - LONG PLANTER  
DESIGN BY FABIO MELIOTA



Steel wire frame  
Steel wire handle  
Aluminium tray  
2 drainage holes at each end of the tray, with plugs  
Feet and tray separable

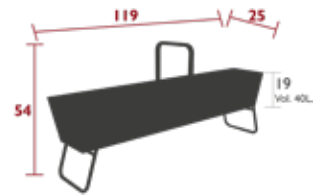

11.5 kg



# BEBOP

5622 - LOW TABLE 120 X 70 CM - H.29 CM

DESIGN BY TRISTAN LOHNER

DOMESTIC PROFESSIONAL INTENSIVE

8 IPAC



Aluminium sheet table top  
Curved steel sheet base  
Aluminium tube supporting cross-beam under the table top

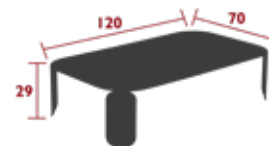

11.4 kg

5626 - LOW TABLE 120 X 70 CM - H.42 CM

DESIGN BY TRISTAN LOHNER

DOMESTIC PROFESSIONAL INTENSIVE

8 IPAC



Aluminium sheet table top  
Curved steel sheet base  
Aluminium tube supporting cross-beam under the table top

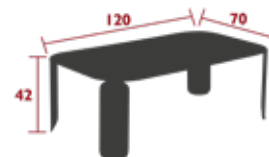

13.9 kg

5628 - LOW CONSOLE TABLE 120 X 40 CM - H. 42 CM

DESIGN BY TRISTAN LOHNER

NEW

DOMESTIC PROFESSIONAL INTENSIVE

8 IPAC



Steel sheet table top  
Intermediate table top made from steel sheet  
Curved steel sheet base  
Steel tube supporting cross-beam under the table tops  
Compatible with :  
OUTDOOR CUSHION Ø 39 CM - BASICS

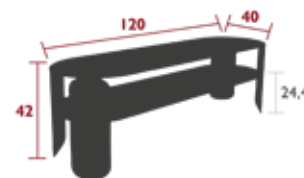

27 kg



BEBOP & ITAC

BEBOP

BEBOP & MOOONI

# BEBOP

5627 - SIDE TABLE Ø 35 CM  
 DESIGN BY TRISTAN LOHNER

DOMESTIC PROFESSIONAL INTENSIVE 10 IPAC 25



Aluminium sheet table top  
 Intermediate table top made from aluminium sheet  
 Curved aluminium sheet base

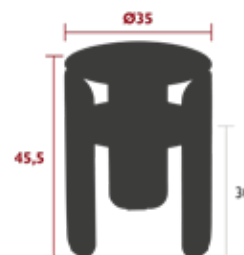

3.2 kg

5610 - LOW TABLE Ø 45 CM  
 DESIGN BY TRISTAN LOHNER

DOMESTIC PROFESSIONAL INTENSIVE 8 IPAC 25



Aluminium sheet table top  
 Curved steel sheet base  
 Aluminium tube supporting cross-beam under the table top

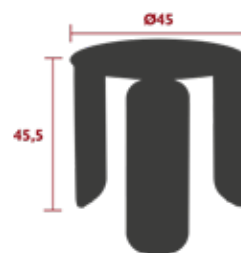

6.5 kg

5613 - LOW TABLE Ø 60 CM  
 DESIGN BY TRISTAN LOHNER

DOMESTIC PROFESSIONAL INTENSIVE 8 IPAC 25



Aluminium sheet table top  
 Curved steel sheet base  
 Aluminium tube supporting cross-beam under the table top

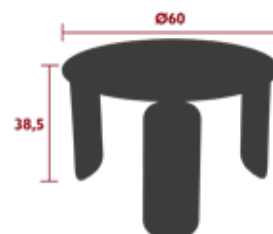

6.8 kg

5616 - LOW TABLE Ø 80 CM  
 DESIGN BY TRISTAN LOHNER

DOMESTIC PROFESSIONAL INTENSIVE 8 IPAC 25



Aluminium sheet table top  
 Curved steel sheet base  
 Aluminium tube supporting cross-beam under the table top

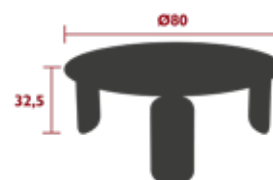

7.7 kg



BEBOP & BELLEVIE



BEBOP, BELLEVIE/NOUJ, COLOR MIX & TRÉFLE



BEBOP

FURNITURE

# BELLEVE

## SUNBRELLA® FABRIC AND METAL COLOURS



- Aluminium frame - light, solid and easy to maintain - available in the 25 colours of the Fermob colour chart,
- Sunbrella® fabric developed exclusively for Fermob by Dickson company, the outdoor fabric specialist.

## CUSHION COVERS DESIGNED FOR OUTDOOR USE

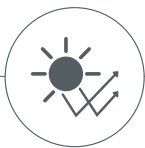

COLOUR-FAST  
IN THE SUN



WATER-REPELLENT  
TREATMENT



BREATHABLE :  
QUICK-DRYING



ANTI-STAIN AND  
MOULD TREATMENT



TEARPROOF  
AND RESISTANT TO  
ABRASION

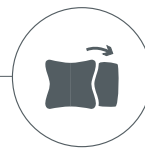

REMOVABLE  
COVERS



MACHINE  
WASHABLE

 Must be brought inside during bad weather.

## NON-SLIP PATTERN



STRAPS WITH  
VELCRO



NON-SLIP PATTERN



## FILLING : HIGH-RESILIENCE POLYURETHANE FOAM

### DINING ARMCHAIR

**Comfort foam**  
density 20 kg/m<sup>3</sup>  
thickness 30 mm

**High-resilience foam**  
density 35 kg/m<sup>3</sup>  
thickness 70 mm

**Comfort foam**  
density 20 kg/m<sup>3</sup>  
thickness 30 mm

**High-resilience foam**  
density 35 kg/m<sup>3</sup>  
thickness 50 mm



**High-resilience PU foam:** Polyurethane-based foam chosen by Fermob for its **ability to return to its initial shape after being deformed**, even after a long period of use.

### SOFAS, LOW ARMCHAIRS AND MODULAR FURNITURE

**Comfort foam**  
density 17 kg/m<sup>3</sup>  
thickness 20 mm

**High-resilience foam**  
density 30 kg/m<sup>3</sup>  
thickness 140 mm

**Firm foam**  
density 65 kg/m<sup>3</sup>  
thickness 40 mm

**High-resilience foam**  
density 35 kg/m<sup>3</sup>  
thickness 90 mm



### PREMIUM SUNLOUNGER

**Comfort foam**  
density 17 kg/m<sup>3</sup>  
thickness 30 mm

**High-resilience foam**  
density 35 kg/m<sup>3</sup>  
thickness 70 mm

**Comfort foam**  
density 17 kg/m<sup>3</sup>



## WINNING COMBINATIONS

**81** **Off-White**  
Recommended with frame in :

83 01 A7 A6 A5 14 26 65 C6 45 C7 D3 D2

**79** **Flannel grey**  
Recommended with frame in :

83 01 A7 A6 A5 26 47 42 92 21 48 82 C6 B9 C7 D3 D2

**A3** **Graphite grey**  
Recommended with frame in :

01 A5 26 42 92 21 48 82 65 43 20 B9 14 C7 D3 D2

**B8** **Grey Taupe**  
Recommended with frame in :

01 A5 47 42 48 82 C6 45 43 20 B9 14 C7 D3 D2

## TO PLACE YOUR ORDER

To identify the left module from the right, stand facing the sofa. The position of the armrest determines its name. A color symbol is available on each product to allow you to quickly visualise the side concerned.



LEFT Module



RIGHT Module

**SPECIFY THE FRAME AND CUSHION COLOURS WHEN PLACING YOUR ORDER : 84452681**

2-SEATER SOFA  
item code 4 numbers

**8445**

STORM GREY  
metal colour code XX

**26**

OFF-WHITE CUSHIONS  
fabric colour code YY

**81**

# BELLEVIE DINING

8402 - CHAIR V2

DESIGN BY PAGNON & PELHAÏTRE

DOMESTIC PROFESSIONAL INTENSIVE

8 IPAC



Flat aluminium frame  
Steel sheet seat  
Aluminium moulded backrest

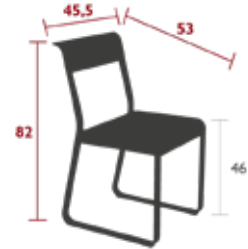

7.5 kg

8405XXYY - DINING ARMCHAIR

DESIGN BY PAGNON & PELHAÏTRE

DOMESTIC PROFESSIONAL INTENSIVE

10 IPAC



Flat aluminium frame  
Perforated aluminium sheet seat  
Perforated aluminium sheet backrest  
Flat aluminium armrests

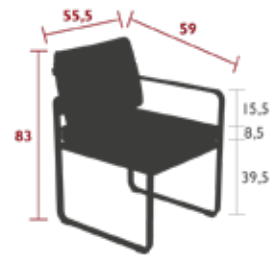

10 kg



The backrest cushion is held in place thanks to its sleeve that easily slips over the armchair's frame.



# BELLEVIE DINING

8410 - BENCH

DESIGN BY PAGNON & PELHAÏTRE



Flat aluminium frame  
Steel sheet seat

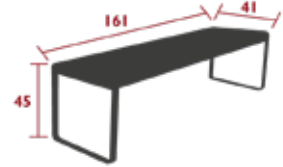

14 kg

8415 - BENCH WITH BACKREST

DESIGN BY PAGNON & PELHAÏTRE



Flat aluminium frame  
Steel sheet seat  
Aluminium sheet backrest

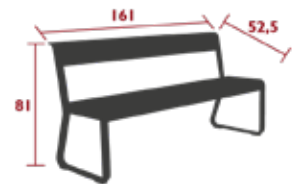

18 kg

8428 - TABLE 74 X 80 CM

DESIGN BY PAGNON & PELHAÏTRE



Steel sheet table top  
Flat aluminium base

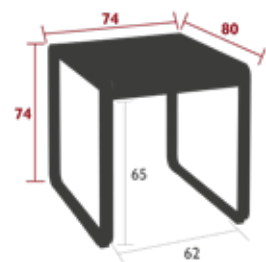

21 kg

8425 - TABLE 140 X 80 CM

DESIGN BY PAGNON & PELHAÏTRE



Steel sheet table top  
Flat aluminium base  
Set of 2 leg risers provided for rain runoff  
Compatible with :  
PROTECTIVE COVER 160 X 100 CM FOR TABLE - COVERS

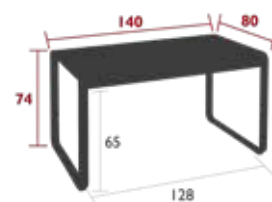

29.6 kg

# BELLEVIE DINING

8420 - TABLE 196 X 90 CM  
 DESIGN BY PAGNON & PELHAÏTRE

DOMESTIC PROFESSIONAL INTENSIVE

10 IPAC

1 x 8

25



Aluminium sheet table top  
 Flat aluminium base  
 Set of 2 leg risers provided for rain runoff  
 Compatible with :  
 PROTECTIVE COVER 210 X 100 FOR TABLE - COVERS

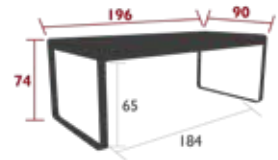

29 kg

8434 - TABLE 196 X 90 CM - WITH STORAGE  
 DESIGN BY PAGNON & PELHAÏTRE

DOMESTIC PROFESSIONAL INTENSIVE

9 IPAC

1 x 8

25



Aluminium sheet table top  
 Flat aluminium base  
 4 teak covers  
 Set of 2 leg risers provided for rain runoff  
 Compatible with :  
 PROTECTIVE COVER 210 X 100 FOR TABLE - COVERS

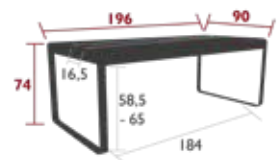

35 kg

BELLEVIE & SURPRISING





BELLEVE, APLO & HOOPIK

# BELLEVIE HIGH DINING

8403 - BAR STOOL

DESIGN BY PAGNON & PELHAÏTRE

DOMESTIC PROFESSIONAL INTENSIVE 10 IPAC 25



Flat aluminium frame  
Aluminium sheet seat

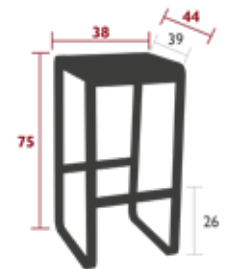

6.5 kg

8467 - HIGH TABLE 74 X 80 CM

DESIGN BY PAGNON & PELHAÏTRE

DOMESTIC PROFESSIONAL INTENSIVE 8 IPAC 25



Steel sheet table top  
Flat aluminium base  
Aluminium profile cross-piece for footrest

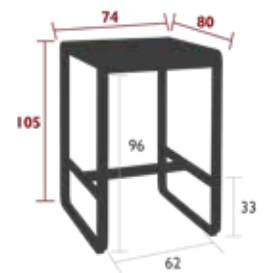

26 kg

8464 - HIGH TABLE 140 X 80 CM

DESIGN BY PAGNON & PELHAÏTRE

DOMESTIC PROFESSIONAL INTENSIVE 8 IPAC 25



Steel sheet table top  
Flat aluminium base  
Aluminium profile cross-piece for footrest  
Set of 2 leg risers provided for rain runoff  
Compatible with :  
PROTECTIVE COVER 160 X 100 CM FOR TABLE - COVERS

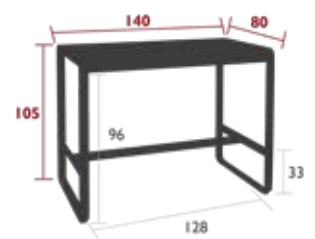

35 kg





# BELLEVIE LOUNGE

## ARMCHAIRS, SEATER OTTOMANS AND SOFAS

8490XXYY - 1-SEATER OTTOMAN  
 DESIGN BY PAGNON & PELHAÏTRE



Flat aluminium frame  
 Perforated steel sheet seat  
 Flame retardant treatment available on request for the UK market  
 - under study  
 Compatible with :  
 1-SEATER-OTTOMAN PROTECTIVE COVER - BELLEVIE

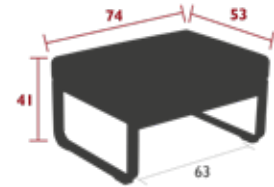

12.5 kg

8494XXYY - 2-SEATER OTTOMAN  
 DESIGN BY PAGNON & PELHAÏTRE



Flat aluminium frame  
 Perforated steel sheet seat  
 Flame retardant treatment available on request for the UK market  
 - under study  
 Compatible with :  
 2-SEATER-OTTOMAN PROTECTIVE COVER - BELLEVIE

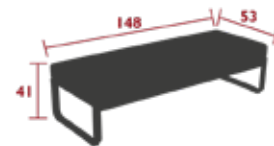

21.2 kg

8440XXYY - ARMCHAIR  
 DESIGN BY PAGNON & PELHAÏTRE



Flat aluminium frame  
 Perforated aluminium sheet seat  
 Tubular aluminium backrest  
 Flat aluminium armrests  
 Flame retardant treatment available on request for the UK market  
 - under study  
 Compatible with :  
 ARMCHAIR PROTECTIVE COVER - BELLEVIE  
 ARMREST SHELF - BELLEVIE

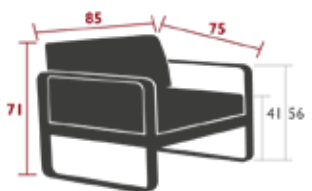

19.5 kg

8445XXYY - 2-SEATER SOFA  
 DESIGN BY PAGNON & PELHAÏTRE



Flat aluminium frame  
 Perforated aluminium sheet seat  
 Tubular aluminium backrest  
 Flat aluminium armrests  
 Flame retardant treatment available on request for the UK market  
 - under study  
 Compatible with :  
 2-SEATER PROTECTIVE COVER - BELLEVIE  
 ARMREST SHELF - BELLEVIE

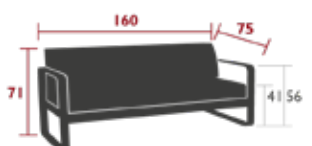

28 kg

# BELLEVIE LOUNGE

## ARMCHAIRS, SEATER OTTOMANS AND SOFAS

8480XXYY - 3-SEATER SOFA  
 DESIGN BY PAGNON & PELHAÛTRE



Flat aluminium frame  
 Perforated aluminium sheet seat  
 Tubular aluminium backrest  
 Flat aluminium armrests  
 Central leg to strengthen the frame, angle bracket to strengthen the backrest  
 Flame retardant treatment available on request for the UK market  
 - under study



39 kg

Compatible with :  
 3-SEATER PROTECTIVE COVER - BELLEVIE  
 ARMREST SHELF - BELLEVIE

8525XXYY - 2-SEATER CLUB SOFA  
 DESIGN BY PAGNON & PELHAÛTRE



Flat aluminium frame  
 Perforated aluminium sheet seat  
 Tubular aluminium backrest  
 Flat aluminium armrests  
 Flame retardant treatment available on request for the UK market  
 - under study



32.4 kg

Compatible with :  
 2-SEATER PROTECTIVE COVER - BELLEVIE

8530XXYY - 3-SEATER CLUB SOFA  
 DESIGN BY PAGNON & PELHAÛTRE



Flat aluminium frame  
 Perforated aluminium sheet seat  
 Tubular aluminium backrest  
 Flat aluminium armrests  
 Central leg to stiffen the frame, angle bracket to strengthen the backrest  
 Flame retardant treatment available on request for the UK market  
 - under study



41.3 kg

Compatible with :  
 3-SEATER PROTECTIVE COVER - BELLEVIE

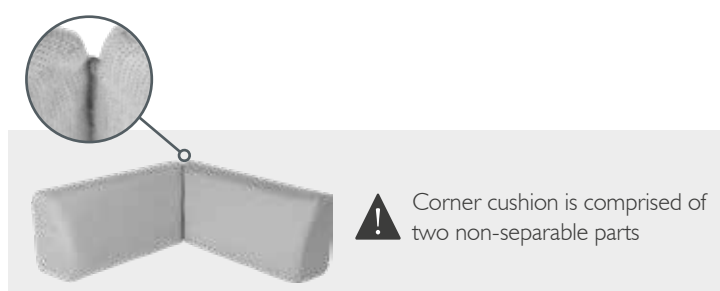



BELLEVIE



BELLEVIE



BELLEVIE, COLOR MIX EVASION

# BELLEVIE LOUNGE

## MODULAR ARMCHAIRS AND SOFAS

8511XXYY - 1-SEATER LEFT MODULE  
 DESIGN BY PAGNON & PELHAÏTRE



Flat aluminium frame  
 Perforated aluminium sheet seat  
 Tubular aluminium backrest  
 Flat aluminium armrests  
 2 connecting strips provided to secure the modules together  
 Flame retardant treatment available on request for the UK market  
 - under study  
 Compatible with :  
 ARMREST SHELF - BELLEVIE  
 ARMCHAIR PROTECTIVE COVER - BELLEVIE

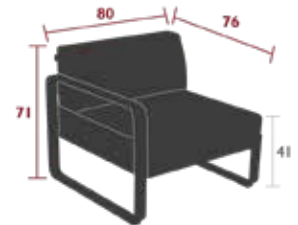

19.3 kg

8521XXYY - 2-SEATER LEFT MODULE  
 DESIGN BY PAGNON & PELHAÏTRE



Flat aluminium frame  
 Perforated aluminium sheet seat  
 Tubular aluminium backrest  
 Flat aluminium armrests  
 2 connecting strips provided to secure the modules together  
 Flame retardant treatment available on request for the UK market  
 - under study  
 Compatible with :  
 ARMREST SHELF - BELLEVIE  
 2-SEATER PROTECTIVE COVER - BELLEVIE



29 kg

8512XXYY - 1-SEATER RIGHT MODULE  
 DESIGN BY PAGNON & PELHAÏTRE



Flat aluminium frame  
 Perforated aluminium sheet seat  
 Tubular aluminium backrest  
 Flat aluminium armrests  
 2 connecting strips provided to secure the modules together  
 Flame retardant treatment available on request for the UK market  
 - under study  
 Compatible with :  
 PROTECTIVE COVER FOR ARMCHAIR - BELLEVIE  
 ARMREST SHELF - BELLEVIE



19.3 kg

8522XXYY - 2-SEATER RIGHT MODULE  
 DESIGN BY PAGNON & PELHAÏTRE



Flat aluminium frame  
 Perforated aluminium sheet seat  
 Tubular aluminium backrest  
 Flat aluminium armrests  
 2 connecting strips provided to secure the modules together  
 Flame retardant treatment available on request for the UK market  
 - under study  
 Compatible with :  
 ARMREST SHELF - BELLEVIE  
 2-SEATER PROTECTIVE COVER - BELLEVIE



29 kg

# BELLEVIE LOUNGE

## MODULAR ARMCHAIRS AND SOFAS

8510XXYY - 1-SEATER CENTRAL MODULE  
 DESIGN BY PAGNON & PELHAÏTRE



Flat aluminium frame  
 Perforated aluminium sheet seat  
 Aluminium tubular backrest  
 4 connecting strips provided to secure the modules together  
 Flame retardant treatment available on request for the UK market  
 - under study  
 Compatible with :  
 1-SEATER PROTECTIVE COVER - BELLEVIE



18.3 kg

8520XXYY - 2-SEATER CENTRAL MODULE  
 DESIGN BY PAGNON & PELHAÏTRE



Flat aluminium frame  
 Perforated aluminium sheet seat  
 Aluminium tubular backrest  
 4 connecting strips provided to secure the modules together  
 Flame retardant treatment available on request for the UK market  
 - under study  
 Compatible with :  
 2-SEATER PROTECTIVE COVER - BELLEVIE



28 kg

8540XXYY - 1-SEATER CORNER MODULE  
 DESIGN BY PAGNON & PELHAÏTRE



Flat aluminium frame  
 Perforated sheet aluminium seat  
 Tubular aluminium backrest  
 4 connecting strips provided to secure the modules together  
 Flame retardant treatment available on request for the UK market  
 - under study  
 Compatible with :  
 PROTECTIVE COVER FOR ARMCHAIR - BELLEVIE

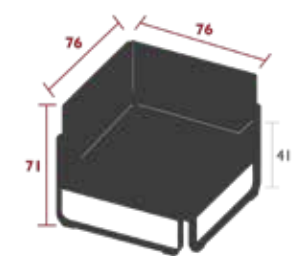

18.5 kg

8523XXYY - 2-SEATER LEFT CORNER MODULE  
 DESIGN BY PAGNON & PELHAÏTRE



Flat aluminium frame  
 Perforated aluminium sheet seat  
 Aluminium tubular backrest  
 Flat aluminium armrests  
 2 connecting strips provided to secure the modules together  
 Flame retardant treatment available on request for the UK market  
 - under study  
 Compatible with :  
 2-SEATER PROTECTIVE COVER - BELLEVIE



30.2 kg

# BELLEVIE LOUNGE

## MODULAR ARMCHAIRS AND SOFAS

8524XXYY - 2-SEATER RIGHT CORNER MODULE  
 DESIGN BY PAGNON & PELHAÏTRE



10  
IPAC



4



Flat aluminium frame  
 Perforated aluminium sheet seat  
 Aluminium tubular backrest  
 Flat aluminium armrests  
 2 connecting strips provided to secure the modules together  
 Flame retardant treatment available on request for the UK market  
 - under study

Compatible with :  
 2-SEATER PROTECTIVE COVER - BELLEVIE



30.2 kg

8452 - RECTANGULAR CONNECTING SHELF  
 DESIGN BY PAGNON & PELHAÏTRE



8  
IPAC



Steel sheet  
 Max. load: 60 kg

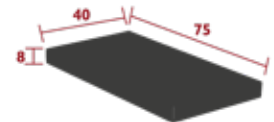

4.5 kg

8409 - ARMREST SHELF



10  
IPAC



Aluminum frame  
 Stainless steel screws  
 Attachment knob with locking system

Compatible with :  
 ARMCHAIR - BELLEVIE  
 2-SEATER SOFA - BELLEVIE  
 3-SEATER SOFA - BELLEVIE  
 2-SEATER LEFT MODULE - BELLEVIE  
 1-SEATER LEFT MODULE - BELLEVIE  
 2-SEATER RIGHT MODULE - BELLEVIE  
 1-SEATER RIGHT MODULE - BELLEVIE  
 ARMCHAIR - LUXEMBOURG  
 HIGH ARMCHAIR - LUXEMBOURG  
 LOUNGE ARMCHAIR - LUXEMBOURG  
 2-SEATER GARDEN BENCH - LUXEMBOURG  
 STEEL ARMCHAIR - LUXEMBOURG



1.4 kg



# BELLEVIE LOUNGE

## COMPOSITIONS

8580XXYY - COMPOSITION 1A  
 DESIGN BY PAGNON & PELHAÏTRE

DOMESTIC | PROFESSIONAL | INTENSIVE

10 IPAC

4

25



1-seater left module (8511)  
 1 rectangular connecting shelf (8452)  
 2-seater right module (8522)

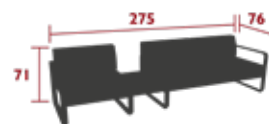

52.8 kg

8581XXYY - COMPOSITION 1B  
 DESIGN BY PAGNON & PELHAÏTRE

DOMESTIC | PROFESSIONAL | INTENSIVE

10 IPAC

4

25



2-seater left module (8521)  
 1 rectangular connecting shelf (8452)  
 1-seater right module (8512)

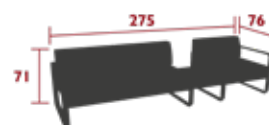

52.8 kg

8588XXYY - COMPOSITION 2  
 DESIGN BY PAGNON & PELHAÏTRE

DOMESTIC | PROFESSIONAL | INTENSIVE

9 IPAC

4

25



2-seater left module (8521)  
 1-seater corner module (8540)  
 2-seater right module (8522)

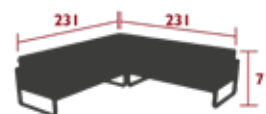

76.5 kg

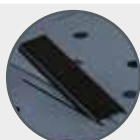

Steel connecting strips





# BELLEVIE LOUNGE

## COMPOSITIONS

8586XXYY - COMPOSITION 3A  
 DESIGN BY PAGNON & PELHAÏTRE



- 1-seater left module (8511)
- 1 rectangular connecting shelf (8452)
- 1-seater central module (8510)
- 1-seater corner module (8540)
- 2-seater right module (8522)

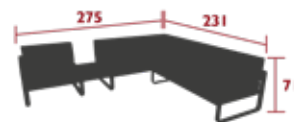

83 kg

8587XXYY - COMPOSITION 3B  
 DESIGN BY PAGNON & PELHAÏTRE



- 2-seater left module (8521)
- 1-seater corner module (8540)
- 1-seater central module (8510)
- 1 rectangular connecting shelf (8452)
- 1-seater right module (8512)

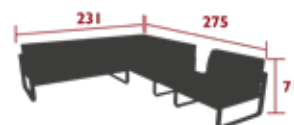

83 kg

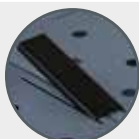

Steel connecting strips



# BELLEVIE LOUNGE

AN INFINITY OF COMPOSITIONS AVAILABLE ON REQUEST

## STRAIGHT COMPOSITION

DO  
x3

- 8480 - 3-seater sofa
- 8490 - 1-seater ottoman

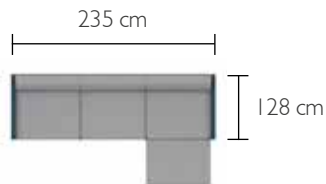

## L-SHAPED COMPOSITION

DO  
x6-7

- 8521 - 2-seater left module
- 8540 - 1-seater corner module
- 8520 - 1 module central 2 places
- 8452 - 1 rectangular connecting shelf
- 8524 - 2-seater right corner module
- 8490 - 1-seater ottoman

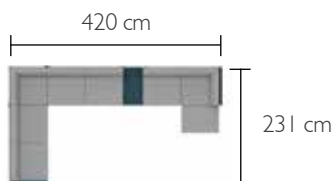

## U-SHAPED COMPOSITION

DO  
x6-9

- 8490 - 1-seater ottoman
- 8521 - 2-seater left module
- 8510 - 1-seater central module
- 8540 - 1-seater corner module
- 8510 - 1-seater central module
- 8452 - 1 rectangular connecting shelf
- 8510 - 1-seater central module
- 8540 - 1-seater corner module
- 8522 - 2-seater right module

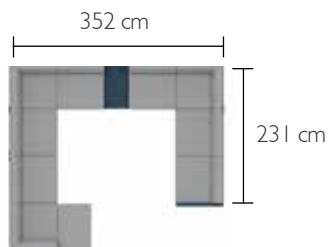

# BELLEVIE LOUNGE

8450 - LOW TABLE 103 X 75 CM

DESIGN BY PAGNON & PELHAÏTRE

DOMESTIC PROFESSIONAL INTENSIVE

10 IPAC



Aluminium sheet table top  
Flat aluminium base

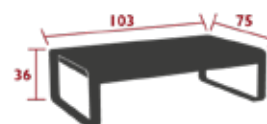

14 kg

8453 - LARGE LOW TABLE 138 X 80 CM

DESIGN BY PAGNON & PELHAÏTRE

NEW

DOMESTIC PROFESSIONAL INTENSIVE

8 IPAC



Steel sheet table top  
Flat aluminium base

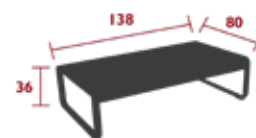

25,5 kg

8459 - MID-HEIGHT TABLE 74 X 80 CM

DESIGN BY PAGNON & PELHAÏTRE

DOMESTIC PROFESSIONAL INTENSIVE

8 IPAC



Steel sheet table top  
Flat aluminium base

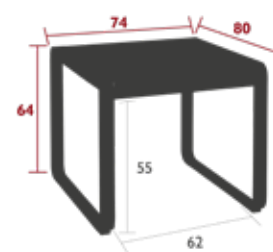

20.5 kg

8457 - MID-HEIGHT TABLE 140 X 80 CM

DESIGN BY PAGNON & PELHAÏTRE

DOMESTIC PROFESSIONAL INTENSIVE

8 IPAC



Steel sheet table top  
Flat aluminium base  
Set of 2 leg risers provided for rain runoff  
Compatible with :  
PROTECTIVE COVER 160 X 100 CM FOR TABLE - COVERS

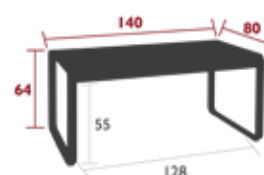

29 kg

# BELLEVIE LOUNGE

8502XXYY - PREMIUM SUNLOUNGER  
 DESIGN BY PAGNON & PELHAÏTRE

NEW

DOMESTIC PROFESSIONAL INTENSIVE

10 IPAC

4

25

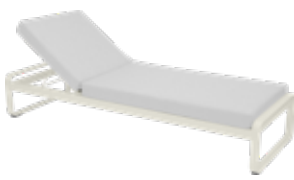

Aluminium frame  
 Perforated aluminium sheet bed  
 Adjustable backrest 3 positions (0°-31°-51°)  
 Adjustment system : painted steel wire  
 Compatible with :  
 HEADREST PREMIUM SUNLOUNGER - BELLEVIE  
 PROTECTIVE COVER FOR PREMIUM SUNLOUNGER - BELLEVIE

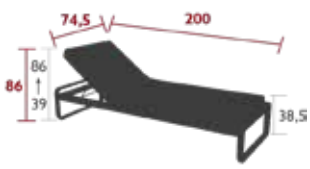

25 kg

8507YY - HEADREST PREMIUM SUNLOUNGER

DOMESTIC PROFESSIONAL INTENSIVE

4



Solution-dyed acrylic Sunbrella® fabric  
 High resilience polyurethane foam  
 Velcro® fastener  
 Compatible with :  
 PREMIUM SUNLOUNGER - BELLEVIE



0.32 kg



BELLEVIE & SHADOO

# BELLEVIE COVERS

BELLEVIE - COVERS



Polyurethane coating polyamide fabric, water-repellent, tear-resistant, UV-resistant and resistant to temperatures between -20 and +45°C  
 Dustproof  
 Quick-drying– no shrinkage of fabric with exposure to sun  
 Easy to install  
 Vent with eyelets for good ventilation of cushions (excluding covers for ottoman, bench and sunlounger)  
 Drawstring closure on bottom section of cover for better fit  
 Storage bag sewn inside cover for optimal storage  
 Do not use as a winter cover

 Clay Grey with Black Cherry trim



## I-SEATER PROTECTIVE COVER

8473



8440  
ARMCHAIR



8510  
I-SEATER CENTRAL MODULE



8512  
I-SEATER RIGHT MODULE



8511  
I-SEATER LEFT MODULE



8540  
I-SEATER CORNER MODULE



## 2 SEATER PROTECTIVE COVER

8474



8445  
2-SEATER SOFA



8520  
2-SEATER CENTRAL MODULE



8521  
2-SEATER LEFT MODULE



8522  
2-SEATER RIGHT MODULE



8523  
2-SEATER LEFT  
CORNER MODULE



8524  
2-SEATER RIGHT  
CORNER MODULE



8525  
2-SEATER CLUB SOFA



**3 SEATER PROTECTIVE COVER**

8475



8480  
3-SEATER SOFA



8530  
3-SEATER CLUB SOFA



**3.5 SEATER PROTECTIVE COVER**

8476



8580 & 8581



**PROTECTIVE COVER  
PREMIUM SUNLOUNGER**

8479



8502XXYY  
PREMIUM SUNLOUNGER



**PROTECTIVE COVER  
2-SEATER OTTOMAN**

8477



8494  
2-SEATER OTTOMAN



**PROTECTIVE COVER  
1-SEATER OTTOMAN**

8478



8490  
1-SEATER OTTOMAN



Learn more about maintaining  
and cleaning your furniture



# BELLEVIE PREMIUM

8418 - BENCH

DESIGN BY PAGNON & PELHAÏTRE

DOMESTIC PROFESSIONAL INTENSIVE

8  
IPAC

3

25



Flat aluminium frame  
Steel sheet seat  
Reinforced parts :  
Strengthened crosspieces for intensive use  
Drilled base for ground mounting

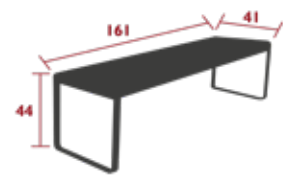

15.5 kg

8432 - TABLE 196 X 90 CM

DESIGN BY PAGNON & PELHAÏTRE

DOMESTIC PROFESSIONAL INTENSIVE

8  
IPAC

3

25



Steel sheet table top  
Flat aluminium base  
Reinforced parts :  
Steel table top (thickness : 1.5mm)  
Strengthened crosspieces for intensive use  
Drilled base for ground mounting  
Set of 2 leg risers provided for rain runoff  
Compatible with :  
PROTECTIVE COVER 210 X 100 FOR TABLE - COVERS

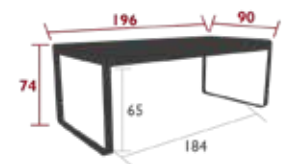

51 kg

# BIARRITZ

2150 - TABLE WITH EXTENSIONS 200/300 X 100 CM

DESIGN BY STUDIO FERMOB

DOMESTIC PROFESSIONAL INTENSIVE

9  
IPAC

14  
x

25  
COLORS



Steel sheet table top  
Tubular aluminium base  
Set of 2 leg risers provided for rain runoff

Compatible with :  
PROTECTIVE COVER 210 X 100 FOR TABLE - COVERS

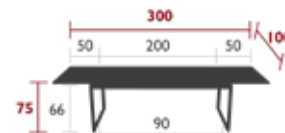

86 kg



BIARRITZ & KINTBURY



BIARRITZ & KINTBURY



# BISTRO



0101 - METAL CHAIR

DOMESTIC PROFESSIONAL INTENSIVE

6<sup>7</sup>  
IPAC



Flat steel frame  
Curved steel slat seat  
Curved steel slat backrest  
Plastic clips for safe folding and unfolding  
One-piece steel cross-pieces  
Compatible with :  
BISTRO OUTDOOR CUSHION 38 X 28 CM - BASICS  
BISTRO OUTDOOR CUSHION 38 X 30 CM - COLOR MIX



4.8 kg



0104 - 2-SEATER BENCH

NEW

DOMESTIC PROFESSIONAL INTENSIVE

6<sup>7</sup>  
IPAC



Steel flat frame  
Steel slat seat  
Steel slat backrest  
Plastic clips for safe folding and unfolding  
One-piece steel cross-pieces



9 kg



BISTRO, IOS, ITAC & MOON!

# BISTRO



0105 - VALET CHAIR

NEW DOMESTIC PROFESSIONAL INTENSIVE 6<sup>7</sup> IPAC 25



Flat steel frame  
 Curved steel slat seat  
 Laser cut steel slat back in the shape of the coat-hanger  
 Plastic clips for safe folding and unfolding  
 One-piece steel cross-pieces  
Compatible with :  
 BISTRO OUTDOOR CUSHION 38 X 28 CM - BASICS  
 BISTRO OUTDOOR CUSHION 38 X 30 CM - COLOR MIX



5 kg

5001 - CLASSIC CHAIR

DOMESTIC PROFESSIONAL INTENSIVE 6<sup>8</sup> IPAC 1



Flat steel frame  
 Curved, lacquered, natural beech slats seat  
 Curved, lacquered, natural beech slats backrest  
 Plastic clips for safe folding and unfolding  
 One-piece steel cross-pieces  
 Available colours: see limited colour chart



4 kg

6301 - DURAFLON® CHAIR

DOMESTIC PROFESSIONAL INTENSIVE 6<sup>8</sup> IPAC 2



Flat steel frame  
 High-quality Duraflon® resin curved slats seat  
 High-quality Duraflon® resin curved slats backrest  
 Plastic clips for safe folding and unfolding  
 One-piece steel cross-pieces  
 Available colours: see limited colour chart



4 kg



**Duraflon®:** Exclusive to Fermob, this polymer (a type of plastic) is used to manufacture Bistro chair slat. Very similar to metal in design, it is a **light, comfortable material** that is guaranteed to be **sturdy and UV-resistant** and **does not retain heat**.

# BISTRO



5107 - NATURAL CHAIR

DOMESTIC PROFESSIONAL INTENSIVE 6<sup>8</sup> IPAC 25



Flat steel frame  
 Curved natural beech slats seat treated with Textrol®  
 Curved natural beech slats backrest treated with Textrol®  
 Plastic clips for safe folding and unfolding  
 One-piece steel cross-pieces



4 kg



**Textrol®** : Natural plant oil-based wood saturator that helps **wood retain its natural appearance for a long time**. Does not form a film or chip off, does not peel away over time, **does not darken under the effect of UV rays**. Fermob uses this product on its Bistro Natural chairs.

0102 - LEATHER CHAIR

DESIGN BY STUDIO FERMOB

NEW INDOOR 3



Steel flat frame  
 Leather covered steel slats seat  
 Leather covered steel slats backrest  
 Plastic clips for safe folding and unfolding  
 One-piece steel cross-pieces  
 Available colours: see limited colour chart



5 kg



The Bistro chair's seats are covered with full-grain leather, promising quality and durability. This mineral tanned leather, a natural material with unrivalled recyclability and immense durability, is respectful of the environment and human health. It is solution-dyed to ensure excellent resistance. The semi-aniline leather guarantees protection against stains and ageing.



# BISTRO



## 1601 - CHAISE LONGUE

DESIGN BY PATRICE HARDY

DOMESTIC PROFESSIONAL INTENSIVE 6 IPAC 25



Flat steel frame  
 Curved steel slat seat  
 Curved steel slat backrest  
 Steel sheet armrests  
 Adjustable backrest 3 positions (42°-54°-67°)  
 Adjustment system : painted steel wire  
 Compatible with :  
 OUTDOOR CUSHION 171 X 44 CM - BASICS  
 HEADREST 44 X 15 X 5.5 CM - COLOR MIX

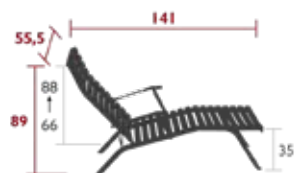

14.5 kg

## 5113 - FOLDABLE BAR CHAIR

DOMESTIC PROFESSIONAL INTENSIVE 6<sup>7</sup> IPAC 25



Flat steel frame  
 Curved steel slat seat  
 Curved steel slat backrest  
 One-piece steel cross-pieces  
 Compatible with :  
 BISTRO OUTDOOR CUSHION 38 X 28 CM - BASICS  
 BISTRO OUTDOOR CUSHION 38 X 30 CM - COLOR MIX



7.5 kg

## 0250 - HIGH TABLE 71 X 71 CM

DOMESTIC PROFESSIONAL INTENSIVE 6<sup>7</sup> IPAC 25



Steel sheet table top  
 Flat steel base

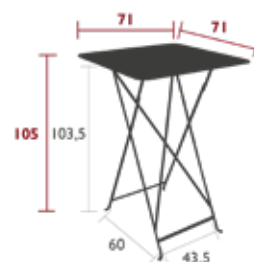

10.8 kg

# BISTRO



0270 - BALCONY TABLE 57 X 77 CM

DESIGN BY STUDIO FERMOB

DOMESTIC PROFESSIONAL INTENSIVE

6 IPAC

2 PERSONS

25 COLORS



Tubular steel frame  
Steel sheet table top  
Adjustable stainless steel fastening system to hang on a balustrade or wall



14 kg

6042 - TABLE 57 X 57 CM

DOMESTIC PROFESSIONAL INTENSIVE

6<sup>7</sup> IPAC

2 PERSONS

25 COLORS



Steel sheet table top  
Flat steel base  
Compatible with :  
TABLE 57 X 37 CM - BISTRO  
TABLE 77 X 57 CM - BISTRO  
TABLE 97 X 57 CM - BISTRO



8 kg

0244 - TABLE 71 X 71 CM

DOMESTIC PROFESSIONAL INTENSIVE

6<sup>7</sup> IPAC

4 PERSONS

25 COLORS



Steel sheet table top  
Flat steel base  
Parasol hole : pole max. Ø 40 mm



10 kg



BISTRO & MOOONI!



BISTRO, COLOR MIX & MOOONI!



BISTRO & PICOLINO

# BISTRO



6034 - TABLE 57 X 37 CM

DOMESTIC | PROFESSIONAL | INTENSIVE

6<sup>7</sup> IPAC

25



Steel sheet table top  
Flat steel base  
Compatible with :  
TABLE 57 X 57 CM - BISTRO  
TABLE 77 X 57 CM - BISTRO  
TABLE 97 X 57 - BISTRO



6.5 kg

0243 - TABLE 77 X 57 CM

DOMESTIC | PROFESSIONAL | INTENSIVE

6<sup>7</sup> IPAC

25



Steel sheet table top  
Flat steel base  
Parasol hole : pole max. Ø 40 mm  
Compatible with :  
TABLE 57 X 57 CM - BISTRO  
TABLE 57 X 37 CM - BISTRO  
TABLE 97 X 57 - BISTRO  
TABLE 117 X 77 - BISTRO



8.5 kg

0239 - TABLE 97 X 57 CM

DOMESTIC | PROFESSIONAL | INTENSIVE

6<sup>7</sup> IPAC

25



Steel sheet table top  
Flat steel base  
Parasol hole : pole max. Ø 40 mm  
Compatible with :  
TABLE 57 X 37 CM - BISTRO  
TABLE 77 X 57 CM - BISTRO  
TABLE 57 X 57 - BISTRO



10 kg

0240 - TABLE 117 X 77 CM

DOMESTIC | PROFESSIONAL | INTENSIVE

6<sup>7</sup> IPAC

25



Steel sheet table top  
Flat steel base  
Parasol hole : pole max. Ø 40 mm  
Compatible with :  
TABLE 77 X 57 CM - BISTRO

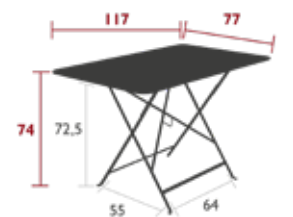

15 kg

# BISTRO



0245 - TABLE Ø 60 CM

DOMESTIC | PROFESSIONAL | INTENSIVE

6<sup>7</sup> IPAC

25



Steel sheet table top  
Flat steel base



6 kg

0233 - TABLE Ø 77 CM

DOMESTIC | PROFESSIONAL | INTENSIVE

6<sup>7</sup> IPAC

25



Steel sheet table top  
Flat steel base  
Parasol hole : pole max. Ø 40 mm



10 kg

0235 - TABLE Ø 96 CM

DOMESTIC | PROFESSIONAL | INTENSIVE

6<sup>7</sup> IPAC

25



Steel sheet table top  
Flat steel base  
Parasol hole : pole max. Ø 40 mm

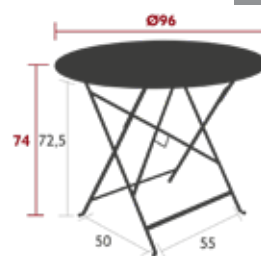

12 kg

0237 - TABLE Ø 117 CM

DOMESTIC | PROFESSIONAL | INTENSIVE

6<sup>7</sup> IPAC

25



Steel sheet table top  
Flat steel base  
Parasol hole : pole max. Ø 40 mm

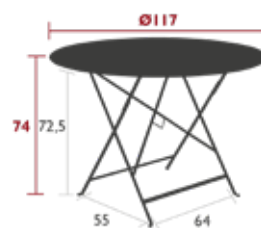

16.5 kg



# BISTRO+



0210 - TABLE Ø 60 CM

DOMESTIC PROFESSIONAL INTENSIVE

7<sup>8</sup>  
IPAC



Steel sheet table top  
Flat steel base  
Reinforced parts:  
Table top (thickness: 1.2 mm)  
No rim, reduces corrosion risk

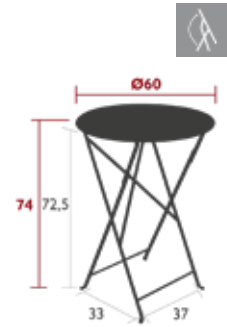

8 kg

0212 - TABLE 71 X 71 CM

DOMESTIC PROFESSIONAL INTENSIVE

7<sup>8</sup>  
IPAC



Steel sheet table top  
Flat steel base  
Parasol hole : pole max. Ø 40 mm  
Reinforced parts:  
Table top (thickness: 1.2 mm)  
No rim, reduces corrosion risk



10.5 kg

# BOLDER GARDEN OFFICE

1050 - 2-SEATER ROUND TABLE WITH SEATS  
 DESIGN BY STUDIO FERMOB

NEW DOMESTIC PROFESSIONAL INTENSIVE 7 IPAC 24



Tubular steel frame  
 Curved sheet steel seat  
 Steel sheet table top  
 Ground fixation recommended  
 Table: height-adjustable pads  
 Available colours: see limited colour chart



1053 - 3-SEATER MODULAR TABLE WITH SEATS  
 DESIGN BY STUDIO FERMOB

NEW DOMESTIC PROFESSIONAL INTENSIVE 7 IPAC 24



Tubular steel frame  
 Curved sheet steel seat  
 Steel sheet table top  
 Table top connection system  
 Ground fixation recommended  
 Table: height-adjustable pads  
 Available colours: see limited colour chart



### ASSEMBLY SET

Please order an assembly set to link two 3-Seater modular tables (2893C)



Watch our video



BOLDER & ADAD DESK

# BOLDER

# GARDEN OFFICE

I047 - HIGH STOOL  
DESIGN BY STUDIO FERMOB

NEW

DOMESTIC PROFESSIONAL INTENSIVE

7 IPAC



Tubular steel frame  
Curved steel sheet seat  
Stainless steel protection on the footrest  
Available colours: see limited colour chart

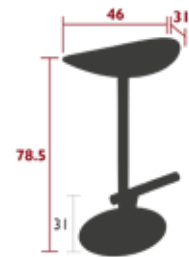

9,5 kg



I057 - COUNTER  
DESIGN BY STUDIO FERMOB

NEW

DOMESTIC PROFESSIONAL INTENSIVE

7 IPAC



Steel sheet table top  
Tubular steel base  
Flat steel cross-piece for footrest  
Height-adjustable pads  
Available colours: see limited colour chart  
Compatible with :  
CONNECTING TABLE TOP - ANGULAR - BOLDER



37 kg



## ASSEMBLY SET

Please order a connection kit to link two counters.



Watch our video



I058 - CONNECTING TABLE TOP - ANGULAR  
DESIGN BY STUDIO FERMOB

WORK IN PROGRESS

NEW

DOMESTIC PROFESSIONAL INTENSIVE



Steel sheet table top  
Connection system included  
Available colours: see limited colour chart  
Compatible with :  
COUNTER - BOLDER

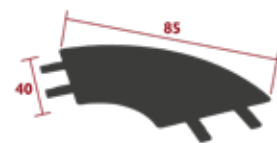

10 kg



# CADIZ

8701 - CHAIR

DESIGN BY ANTOINE LESUR



Tubular aluminium frame  
 Duo or Stereo OTF Batyline® outdoor fabric seat - high-tenacity 100% polyester thread coated in solution-dyed PVC  
 Duo or Stereo OTF Batyline® outdoor fabric backrest - high-tenacity 100% polyester thread coated in solution-dyed PVC  
Stacking capacity : x 10 (Height – stacked : 113 cm)  
 Available colours: see limited colour chart



2.9 kg

8702 - ARMCHAIR

DESIGN BY ANTOINE LESUR



Tubular aluminium frame  
 Duo or Stereo OTF Batyline® outdoor fabric seat - high-tenacity 100% polyester thread coated in solution-dyed PVC  
 Duo or Stereo OTF Batyline® outdoor fabric backrest - high-tenacity 100% polyester thread coated in solution-dyed PVC  
 Hydroformed aluminium tubular armrests  
Stacking capacity : x 10 (Height – stacked : 113 cm)  
 Available colours: see limited colour chart

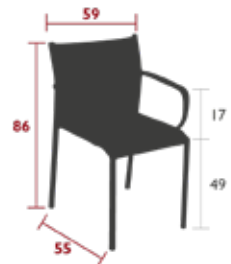

3.4 kg

8704 - LOW ARMCHAIR

DESIGN BY ANTOINE LESUR



Tubular aluminium frame  
 Duo or Stereo OTF Batyline® outdoor fabric seat - high-tenacity 100% polyester thread coated in solution-dyed PVC  
 Duo or Stereo OTF Batyline® outdoor fabric backrest - high-tenacity 100% polyester thread coated in solution-dyed PVC  
 Hydroformed aluminium tubular armrests  
Stacking capacity : x 10 (Height – stacked : 108 cm)  
 Available colours: see limited colour chart

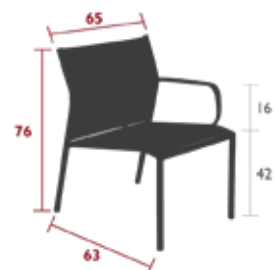

3.5 kg



**Hydroforming** : A manufacturing process used for Cadiz's armrests, in which a material is **shaped by injecting a high-pressure fluid** and working with the material. This process was previously mainly used in high-tech industries such as aerospace.

# CADIZ

8703 - BAR CHAIR  
 DESIGN BY ANTOINE LESUR

DOMESTIC PROFESSIONAL INTENSIVE 10 IPAC 



Tubular aluminium frame  
 Stereo OTF Batyline® outdoor fabric seat - high-tenacity  
 100% polyester thread coated in solution-dyed PVC  
 Stereo OTF Batyline® outdoor fabric backrest - high-tenacity  
 100% polyester thread coated in solution-dyed PVC  
 Stacking capacity : x 8 (Height – stacked : 123 cm)  
 Available colours: see limited colour chart

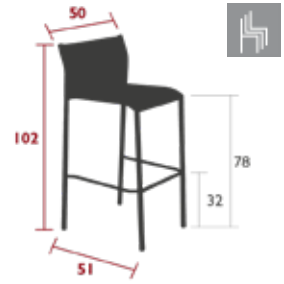

3 kg

8705 - HIGH ARMCHAIR  
 DESIGN BY ANTOINE LESUR

DOMESTIC PROFESSIONAL INTENSIVE 10 IPAC 



Tubular aluminium frame  
 Duo or Stereo OTF Batyline® outdoor fabric seat - high-tenacity  
 100% polyester thread coated in solution-dyed PVC  
 Duo or Stereo OTF Batyline® outdoor fabric backrest - high-tenacity  
 100% polyester thread coated in solution-dyed PVC  
 Hydroformed aluminium tubular armrests  
 Stacking capacity : x 8 (Height – stacked : 126 cm)  
 Available colours: see limited colour chart

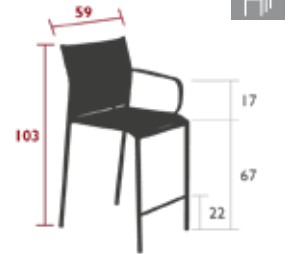

3.3 kg



CADIZ, CALVI & SALSA

CALVI & CADIZ



CALVI, CADIZ & APLÓ



# CALVI

8753 - TABLE 140 X 140 CM  
 DESIGN BY ANTOINE LESUR

DOMESTIC | PROFESSIONAL | INTENSIVE

10 IPAC

6

25



Aluminium sheet table top  
 Tubular aluminium base  
 Height-adjustable pads  
 Set of 2 leg risers provided for rain runoff

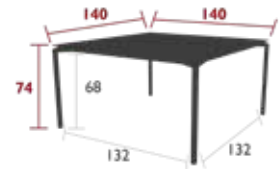

47.5 kg

8744 - TABLE 160 X 80 CM  
 DESIGN BY ANTOINE LESUR

DOMESTIC | PROFESSIONAL | INTENSIVE

10 IPAC

6

25



Aluminium sheet table top  
 Tubular aluminium base  
 Height-adjustable pads  
 Set of 2 leg risers provided for rain runoff  
 Compatible with :  
 PROTECTIVE COVER 160 X 100 CM FOR TABLE - COVERS

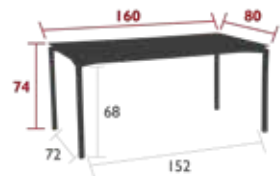

35 kg

8740 - TABLE 195 X 95 CM  
 DESIGN BY ANTOINE LESUR

DOMESTIC | PROFESSIONAL | INTENSIVE

10 IPAC

10

25



Aluminium sheet table top  
 Tubular aluminium base  
 Height-adjustable pads  
 Set of 2 leg risers provided for rain runoff  
 Compatible with :  
 PROTECTIVE COVER 210 X 100 FOR TABLE - COVERS

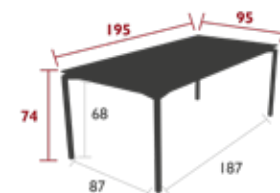

45 kg

8750 - HIGH TABLE 160 X 80 CM  
 DESIGN BY ANTOINE LESUR

DOMESTIC | PROFESSIONAL | INTENSIVE

10 IPAC

6

25



Aluminium sheet table top  
 Tubular aluminium base  
 Height-adjustable pads  
 Set of 2 leg risers provided for rain runoff  
 Compatible with :  
 PROTECTIVE COVER 160 X 100 CM FOR TABLE - COVERS

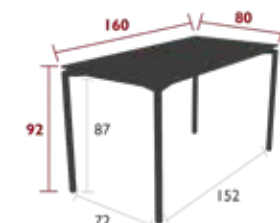

35.5 kg

# CARACTÈRE

5933 - TABLE 128 X 90 CM

DESIGN BY STUDIO FERMOB

DOMESTIC | PROFESSIONAL | INTENSIVE

8  
IPAC

6

25



Steel sheet table top  
Tubular steel base  
Aluminium frame beneath table top  
Compatible with :  
TABLE 128 X 128 CM - CARACTÈRE  
TABLE 190 X 90 CM - CARACTÈRE



22 kg

5930 - TABLE 128 X 128 CM

DESIGN BY STUDIO FERMOB

DOMESTIC | PROFESSIONAL | INTENSIVE

8  
IPAC

8

25



Steel sheet table top  
Tubular steel base  
Aluminium frame beneath table top  
Compatible with :  
TABLE 128 X 90 CM - CARACTÈRE



27 kg

5931 - TABLE 190 X 90 CM

DESIGN BY STUDIO FERMOB

DOMESTIC | PROFESSIONAL | INTENSIVE

8  
IPAC

10

25



Steel sheet table top  
Tubular steel base  
Aluminium frame beneath table top  
Compatible with :  
TABLE 128 X 90 CM - CARACTÈRE



30 kg

5932 - TABLE Ø 128 CM

DESIGN BY STUDIO FERMOB

DOMESTIC | PROFESSIONAL | INTENSIVE

8  
IPAC

8

25



Steel sheet table top  
Tubular steel base  
Aluminium frame beneath table top



23 kg





### CARACTÈRE 4 TABLE FORMATS TO ADAPT TO ANY SPACE

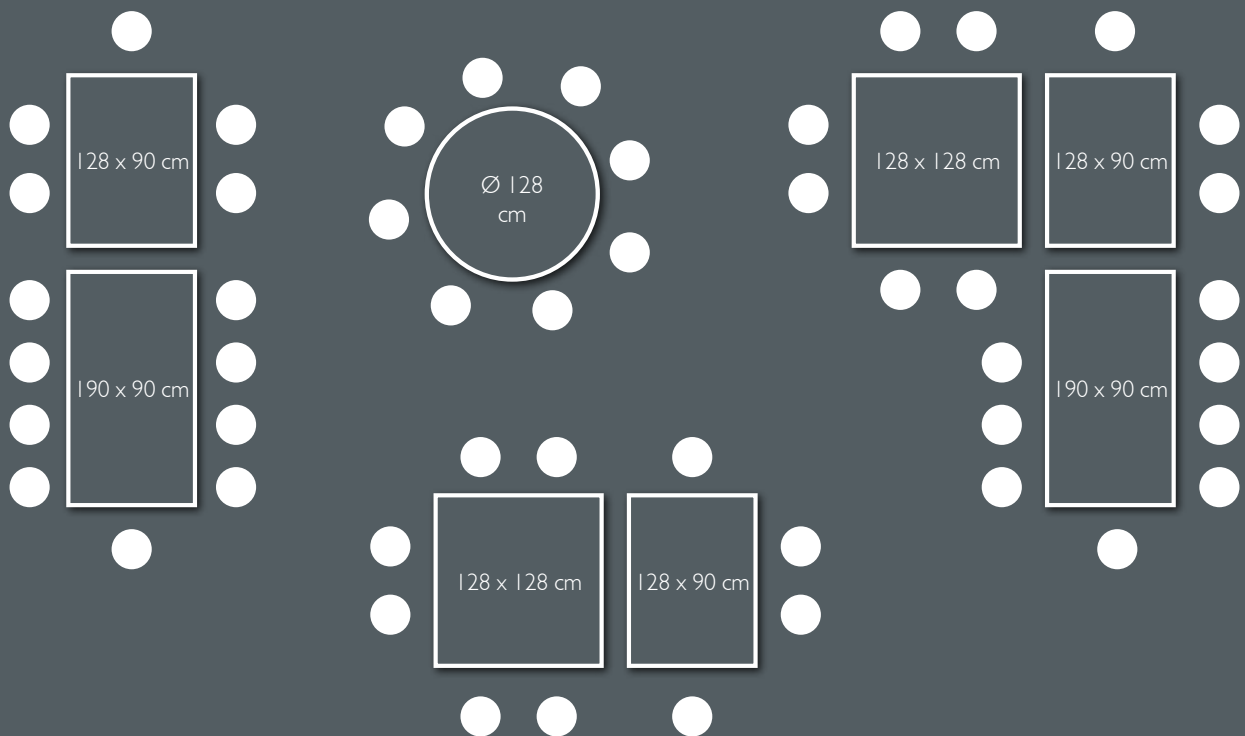

# CARGO

0248 - TABLE 128 X 90 CM  
 DESIGN BY STUDIO FERMOB

DOMESTIC | PROFESSIONAL | INTENSIVE

6 IPAC

6 PEOPLE

17 COLOURS



Steel sheet table top  
 Steel angle base  
 Available colours: see limited colour chart  
 Compatible with :  
 TABLE 190 X 90 CM - CARGO  
 TABLE 128 x 128 CM - CARGO



27.50 kg

0241 - TABLE 128 X 128 CM  
 DESIGN BY STUDIO FERMOB

DOMESTIC | PROFESSIONAL | INTENSIVE

6 IPAC

6 PEOPLE

17 COLOURS



Steel sheet table top  
 Steel angle base  
 Available colours: see limited colour chart  
 Compatible with :  
 TABLE 128 X 90 CM - CARGO

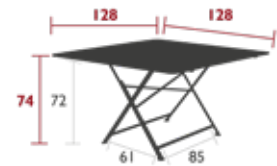

29 kg

0247 - TABLE 190 X 90 CM  
 DESIGN BY STUDIO FERMOB

DOMESTIC | PROFESSIONAL | INTENSIVE

6 IPAC

6 PEOPLE

17 COLOURS



Steel sheet table top  
 Steel angle base  
 Available colours: see limited colour chart  
 Compatible with :  
 TABLE 128 X 90 CM - CARGO

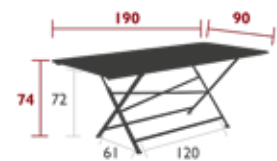

39.5 kg

6-10 PEOPLE,  
 3 STANDARD TABLE FORMATS THAT CAN  
 BE COMBINED

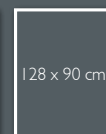
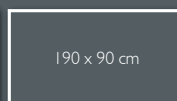
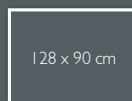

# CHARIVARI

I025 - BENCH

DESIGN BY JULIETTE LIBERMAN

DOMESTIC PROFESSIONAL INTENSIVE

9  
IPAC

6

25



Flat aluminium curved seat  
Flat aluminium curved backrest  
Liquorice steel base  
Delivered assembled

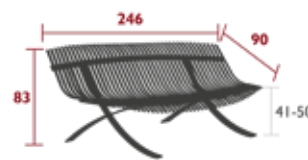

88 kg

# COCOTTE

4702 - STOOL H.45 CM  
DESIGN BY STUDIO FERMOB

NEW

DOMESTIC PROFESSIONAL INTENSIVE

6<sup>7</sup>  
IPAC



Steel wire frame  
Steel sheet seat



2.6 kg

4720 - LOW TABLE, REMOVABLE TABLE TOP 55 X 44.5 CM  
DESIGN BY STUDIO FERMOB

DOMESTIC PROFESSIONAL INTENSIVE

6<sup>8</sup>  
IPAC



Aluminium sheet table top  
Steel wire base



3 kg

4703 - OCCASIONAL TABLE Ø 34 CM  
DESIGN BY STUDIO FERMOB

DOMESTIC PROFESSIONAL INTENSIVE

6<sup>7</sup>  
IPAC



Steel sheet table top  
Steel wire base

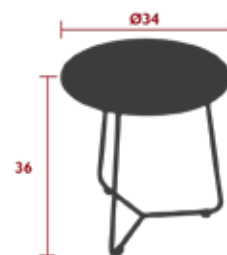

2 kg



COCOTTE



COCOTTE & MOONI:



COCOTTE, MONCEAU, ALTO & APLÒ

# COSTA

8143 - TABLE 80 X 80 CM

DOMESTIC PROFESSIONAL INTENSIVE

9 IPAC

4

25



Aluminium slat table top  
Tubular aluminium base

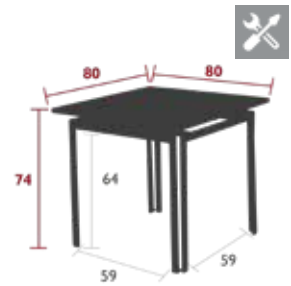

14.5 kg

8160 - TABLE 160 X 80 CM

DOMESTIC PROFESSIONAL INTENSIVE

9 IPAC

6

25



Aluminium slat table top  
Tubular aluminium base  
Compatible with :  
PROTECTIVE COVER 160 X 100 CM FOR TABLE - COVERS

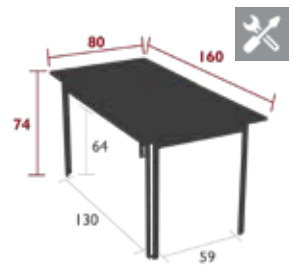

21 kg

8147 - TABLE WITH EXTENSIONS 160/240 X 90 CM

DOMESTIC PROFESSIONAL INTENSIVE

9 IPAC

10

25



Aluminium slat table top  
Tubular aluminium base



32 kg



COSTA

# CRAFT

1970 - TABLE 143 X 143 CM

DOMESTIC | PROFESSIONAL | INTENSIVE

7  
IPAC

8

25



Steel sheet table top  
Tubular steel base  
Set of 2 leg risers provided for rain runoff

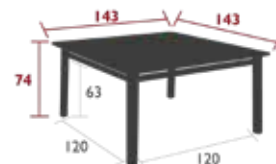

46 kg



CRAFT & SURPRISING

FURNITURE

# CROISSETTE

1804 - ARMCHAIR

DESIGN BY PASCAL MOURGUE

DOMESTIC | PROFESSIONAL | INTENSIVE | 10 IPAC



Tubular aluminium frame  
 Outdoor woven polyethylene fibre seat  
 Outdoor woven polyethylene fibre backrest  
 Silencing pads  
 Stacking capacity: x 4 (Height – stacked: 100 cm)  
 Available colours: see limited colour chart



3.2 kg

1805 - 2-SEATER BENCH

DESIGN BY PASCAL MOURGUE

DOMESTIC | PROFESSIONAL | INTENSIVE | 10 IPAC



Tubular aluminium frame  
 Outdoor woven polyethylene fibre seat  
 Outdoor woven polyethylene fibre backrest  
 Silencing pads  
 Stacking capacity: x 4 (Height – stacked: 100 cm)  
 Available colours: see limited colour chart



6 kg

1806 - 3-SEATER XL BENCH

DESIGN BY PASCAL MOURGUE

DOMESTIC | PROFESSIONAL | INTENSIVE | 10 IPAC



Tubular aluminium frame  
 Outdoor woven polyethylene fibre seat  
 Outdoor woven polyethylene fibre backrest  
 Silencing pads  
 Available colours: see limited colour chart

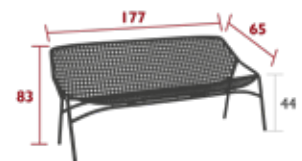

10.1 kg

1820 - LOW TABLE 97 X 57 CM

DESIGN BY PASCAL MOURGUE

DOMESTIC | PROFESSIONAL | INTENSIVE | 7 IPAC



Steel sheet table top  
 Tubular steel base

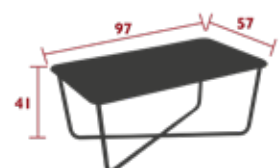

9 kg





# DUNE

I 308 - SUNLOUNGER  
DESIGN BY PASCAL MOURGUE

DOMESTIC PROFESSIONAL INTENSIVE

7  
IPAC



Flat steel frame  
Duo or Stereo OTF Batyline® outdoor fabric bed - high-tenacity  
100% polyester thread coated in solution-dyed PVC  
Adjustable backrest 4 positions (0°-20°-36°-56°)  
Integrated wheels  
Adjustment system : painted steel wire  
Available colours: see limited colour chart  
Compatible with :  
HEADREST 44 X 15 X 5.5 CM - COLOR MIX



19.2 kg



DUNE & BISTRO

# DUNE PREMIUM

I201 - CHAIR

DESIGN BY PASCAL MOURGUE

DOMESTIC PROFESSIONAL INTENSIVE

7<sup>8</sup>  
IPAC



Flat steel frame  
Duo or Stereo OTF Batyline® outdoor fabric seat - high-tenacity  
100% polyester thread coated in solution-dyed PVC  
Duo or Stereo OTF Batyline® outdoor fabric backrest - high-tenacity  
100% polyester thread coated in solution-dyed PVC  
Reinforced backrest  
Available colours: see limited colour chart



4.6 kg



FURNITURE

I202 - ARMCHAIR

DESIGN BY PASCAL MOURGUE

DOMESTIC PROFESSIONAL INTENSIVE

7<sup>8</sup>  
IPAC



Flat steel frame  
Duo or Stereo OTF Batyline® outdoor fabric seat - high-tenacity  
100% polyester thread coated in solution-dyed PVC  
Duo or Stereo OTF Batyline® outdoor fabric backrest - high-tenacity  
100% polyester thread coated in solution-dyed PVC  
Reinforced backrest  
Steel slat armrests  
Available colours: see limited colour chart



6 kg



# FACE A FACE

3209 - WRITING DESK

DESIGN BY PASCAL MOURGUE



Fixes to the wall  
 Steel frame  
 Steel handle  
 Aluminium base  
 Aluminium shelves  
 Fold-away door with integrated MDF blotter covered in imitation leather.  
 Magnet door locking mechanism  
 Internal compartments: keyring, magazine rack, letter holder, glasses stand, smartphone and tablet holder, double 2.4A USB socket, 230V electrical socket, versatile compartment for pens, erasers, etc.  
 Power cable (2 m long)  
 Can be adapted for compatibility with UK power upon demand, and with a longer lead time (minimum 1000 pieces)  
 Anthracite frame, internal compartments available in 3 colours  
 Available colours: see limited colour chart



32 kg

32094782 ● Cactus  
 320947A5 ● Clay Grey

320947C6 ● Honey



FACE À FACE



FACE À FACE, ANGE & MOON!

# FACTO

## 2501 - CHAIR

DESIGN BY PATRICK JOUIN

DOMESTIC PROFESSIONAL INTENSIVE

6<sup>8</sup>  
IPAC



Tubular steel frame  
Curved steel sheet seat  
Curved steel sheet backrest  
Silencing pads  
Stacking capacity : x 4 (Height – stacked : 93 cm)

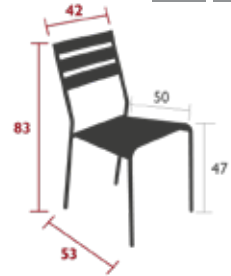

5.4 kg

## 2503 - BAR CHAIR

DESIGN BY PATRICK JOUIN

DOMESTIC PROFESSIONAL INTENSIVE

6<sup>8</sup>  
IPAC



Tubular steel frame  
Curved steel sheet seat  
Curved steel sheet backrest  
Silencing pads



6.2 kg



FACTO & CALVI

# FLOREÁL

0230 - TABLE Ø 60 CM

DOMESTIC PROFESSIONAL INTENSIVE 6<sup>7</sup> IPAC 2 25



Perforated steel sheet table top  
Flat steel base



6 kg

0234 - TABLE Ø 77 CM

DOMESTIC PROFESSIONAL INTENSIVE 6<sup>7</sup> IPAC 4 25



Perforated steel sheet table top  
Flat steel base  
Parasol hole : pole max. Ø 39 mm



10 kg

0236 - TABLE Ø 96 CM

DOMESTIC PROFESSIONAL INTENSIVE 6<sup>7</sup> IPAC 5 25



Perforated steel sheet table top  
Flat steel base  
Parasol hole : pole max. Ø 39 mm

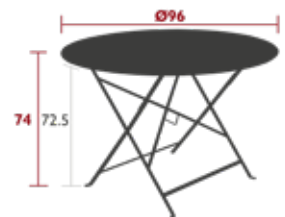

11.8 kg

# FLOWER

7110 - PEDESTAL TABLE Ø 67 CM

DESIGN BY HARALD GUGGENBICHLER

DOMESTIC PROFESSIONAL INTENSIVE 8 IPAC 2 25



Steel sheet table top  
Steel wire base



7.8 kg



FLOWER & SIXTIES

FURNITURE

# GUINGUETTE

I062 - SIDE WHEELED TABLE WITH SOLID DOUBLE TOP

DOMESTIC PROFESSIONAL INTENSIVE

6<sup>7</sup>  
IPAC



Steel wire frame  
Steel sheet table top  
Integrated wheels

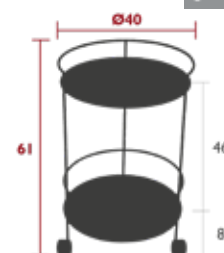

4.3 kg

I061 - SIDE TABLE WITH PERFORATED DOUBLE TOP

DOMESTIC PROFESSIONAL INTENSIVE

6<sup>7</sup>  
IPAC



Steel wire frame  
Perforated steel sheet table top



4.4 kg



GUINGUETTE



# KALAHARI

3267 - SHADED TABLE  
DESIGN BY STUDIO FERMOB

NEW

DOMESTIC | PROFESSIONAL | INTENSIVE

6  
IPAC

2  
X2

1

25



Steel sheet table top  
Tubular steel base  
Outdoor fabric solution-dyed 100% acrylic



16 kg

3 POSITIONS



# KATE

7302 - ARMCHAIR  
DESIGN BY PATRICK JOUIN

DOMESTIC PROFESSIONAL INTENSIVE

7  
IPAC



Tubular steel frame  
Steel sheet seat  
Perforated steel sheet backrest  
Silencing pads  
Stacking capacity : x 4 (Height – stacked : 110 cm)

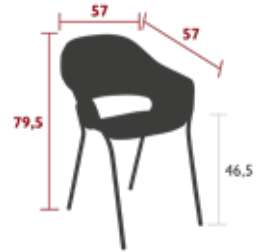

8.8 kg



KATE - LUXEMBOURG & MOONNI

# KINTBURY

5810 - CHAIR

DESIGN BY TERENCE CONRAN

DOMESTIC PROFESSIONAL INTENSIVE

7  
IPAC



Steel wire frame  
Steel sheet seat  
Steel wire backrest  
Stacking capacity : x 6 (Height – stacked : 95.4 cm)



5.8 kg



# LA MÔME

3701 - CHAIR  
DESIGN BY OLIVIER GENÇE

DOMESTIC PROFESSIONAL INTENSIVE

6<sup>7</sup>  
IPAC



Flat steel frame  
Curved steel slat seat  
Curved steel slat backrest  
Plastic clips for safe folding and unfolding  
One-piece steel cross-pieces



6.1 kg



LA MÔME & PLEIN AIR

# LATITUDE

4911 - CHAIR

DESIGN BY PASCAL MOURGUE

DOMESTIC PROFESSIONAL INTENSIVE

7<sup>8</sup>  
IPAC



Flat steel frame

Duo or Stereo OTF Batyline® outdoor fabric seat - high-tenacity

100% polyester thread coated in solution-dyed PVC

Duo or Stereo OTF Batyline® outdoor fabric backrest - high-tenacity

100% polyester thread coated in solution-dyed PVC

Available colours: see limited colour chart



4.2 kg

LATITUDE, CARGO & GUINQUETTE



# LORETTE DINING

5711 - CHAIR  
DESIGN BY FRÉDÉRIC SOFIA



Tubular steel frame  
Steel sheet seat  
Perforated steel sheet backrest  
Stacking capacity : x 4 (Height – stacked : 94 cm)



6 kg

5712 - ARMCHAIR  
DESIGN BY FRÉDÉRIC SOFIA



Tubular steel frame  
Steel sheet seat  
Perforated steel sheet backrest  
Steel wire armrests  
Stacking capacity : x 4 (Height – stacked : 94 cm)



6.8 kg

5761 - TABLE Ø 110 CM  
DESIGN BY FRÉDÉRIC SOFIA



Perforated steel sheet table top  
Tubular steel base



22 kg

5762 - OVAL TABLE 160 X 90 CM  
DESIGN BY FRÉDÉRIC SOFIA



Perforated steel sheet table top  
Tubular steel base  
Compatible with :  
PROTECTIVE COVER 160 X 100 CM FOR TABLE - COVERS

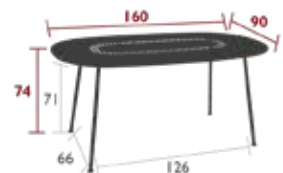

25 kg

LORETTA & MOONNI



LORETTA



LORETTA



FURNITURE

# LORETTE LOUNGE

5713 - LOW ARMCHAIR  
DESIGN BY FRÉDÉRIC SOFIA

DOMESTIC | PROFESSIONAL | INTENSIVE

6 IPAC



Tubular steel frame  
Steel sheet seat  
Perforated steel sheet backrest  
Steel wire armrests



8.6 kg

5714 - CONVERSATION BENCH  
DESIGN BY FRÉDÉRIC SOFIA

DOMESTIC | PROFESSIONAL | INTENSIVE

6 IPAC



Tubular steel frame  
Aluminium sheet seat  
Perforated steel sheet backrest  
Steel wire armrests

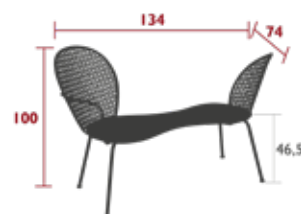

21 kg

5740 - LOW TABLE Ø 80 CM  
DESIGN BY FRÉDÉRIC SOFIA

DOMESTIC | PROFESSIONAL | INTENSIVE

7 IPAC



Perforated steel sheet table top  
Tubular steel base

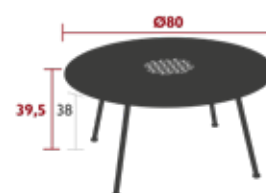

9 kg



# LOUISIANE

1000 - BENCH 150 CM

DOMESTIC PROFESSIONAL INTENSIVE

7  
IPAC

3

25



Steel angle frame  
Tubular steel seat  
Tubular steel backrest



33.3 kg

1001 - BENCH 200 CM

DOMESTIC PROFESSIONAL INTENSIVE

7  
IPAC

4

25



Steel angle frame  
Tubular steel seat  
Tubular steel backrest



36.8 kg



LOUISIANE, SALSA, COLOR MIX & TRÉFLE

# LOUVRE

0801 - CHAIR

DOMESTIC PROFESSIONAL INTENSIVE

6<sup>7</sup>  
IPAC



Steel wire frame  
Perforated steel sheet seat  
Steel wire and flat backrest  
Stacking capacity : x 10 (Height – stacked : 157 cm)  
Compatible with :  
OUTDOOR CUSHION Ø 39 CM - BASICS  
OUTDOOR CUSHION Ø 40 CM - COLOR MIX



5.5 kg

0802 - ARMCHAIR

DOMESTIC PROFESSIONAL INTENSIVE

6<sup>7</sup>  
IPAC



Steel wire frame  
Perforated steel sheet seat  
Steel wire and flat backrest  
Steel wire armrests  
Stacking capacity : x 7 (Height – stacked : 140 cm)  
Compatible with :  
OUTDOOR CUSHION Ø 43 CM - BASICS

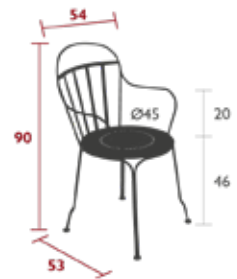

6.5 kg

# LUXEMBOURG DINING

4111 - STOOL  
 DESIGN BY FRÉDÉRIC SOFIA

DOMESTIC PROFESSIONAL INTENSIVE 9 IPAC 25



Tubular aluminium frame  
 Curved aluminium slat seat  
 Silencing pads  
Stacking capacity : x 10 (Height – stacked : 92 cm)  
Compatible with :  
 OUTDOOR CUSHION 37 X 41 CM - BASICS  
 OUTDOOR CUSHION 41 X 38 CM - COLOR MIX

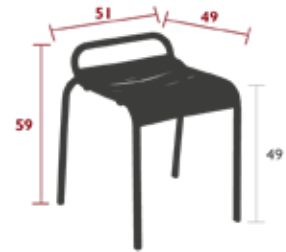

2.6 kg

4101 - CHAIR  
 DESIGN BY FRÉDÉRIC SOFIA

DOMESTIC PROFESSIONAL INTENSIVE 9 IPAC 25



Tubular aluminium frame  
 Curved aluminium slat seat  
 Curved aluminium slat backrest  
 Silencing pads  
Stacking capacity : x 10 (Height – stacked : 123.5 cm)  
Compatible with :  
 SKIN OUTDOOR CUSHION 45 X 40 CM - BASICS  
 OUTDOOR CUSHION 37 X 41 CM - BASICS  
 OUTDOOR CUSHION 41 X 38 CM - COLOR MIX



3.8 kg

4102 - ARMCHAIR  
 DESIGN BY FRÉDÉRIC SOFIA

DOMESTIC PROFESSIONAL INTENSIVE 9 IPAC 25



Tubular aluminium frame  
 Curved aluminium slat seat  
 Curved aluminium slat backrest  
 Aluminium slat armrests  
 Silencing pads  
Stacking capacity : x 8 (Height – stacked : 116 cm)  
Compatible with :  
 SKIN OUTDOOR CUSHION 45 X 40 CM - BASICS  
 OUTDOOR CUSHION 37 X 41 CM - BASICS  
 OUTDOOR CUSHION 41 X 38 CM - COLOR MIX  
 ARMREST SHELF - BELLEVIE



4.2 kg

# LUXEMBOURG DINING

4114 - COMPACT BENCH  
DESIGN BY FRÉDÉRIC SOFIA

NEW DOMESTIC PROFESSIONAL INTENSIVE 9 IPAC 25



Tubular aluminium frame  
Curved aluminium slat seat  
Silencing pads  
Stacking capacity : x 4 (Height – stacked : 63 cm)

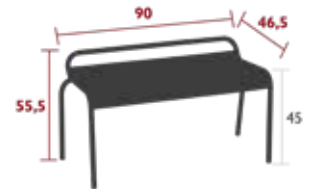

7 kg

4115 - 2/3-SEATER BENCH WITH BACKREST  
DESIGN BY FRÉDÉRIC SOFIA

DOMESTIC PROFESSIONAL INTENSIVE 9 IPAC 25



Tubular aluminium frame  
Curved aluminium slat seat  
Curved aluminium slat backrest  
Silencing pads  
Stacking capacity : x 4 (Height – stacked : 100 cm)  
Compatible with :  
BENCH OUTDOOR CUSHION 106 X 35 CM - COLOR MIX



10.3 kg

4110 - 3/4-SEATER BENCH  
DESIGN BY FRÉDÉRIC SOFIA

DOMESTIC PROFESSIONAL INTENSIVE 9 IPAC 25



Tubular aluminium frame  
Curved aluminium slat seat  
Silencing pads

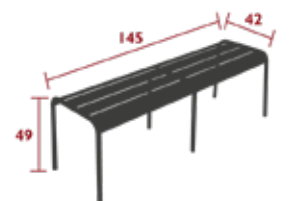

7 kg

4164 - SIDE BAR / TROLLEY BAR  
DESIGN BY FRÉDÉRIC SOFIA

DOMESTIC PROFESSIONAL INTENSIVE 9 IPAC 25



Tubular aluminium frame  
Removable aluminium sheet table top  
Removable sheet dimensions : 53 x 46,5 x 5,5 cm  
Aluminium wheels with flexible PVC tread: painted aluminium wheel bodies  
Silencing pads



11.5 kg



# LUXEMBOURG DINING

4142 - PEDESTAL TABLE 71 X 71 CM WITH SOLID TOP  
 DESIGN BY FRÉDÉRIC SOFIA



Steel sheet table top  
 Tubular aluminium base  
 Aluminium base, steel ballast

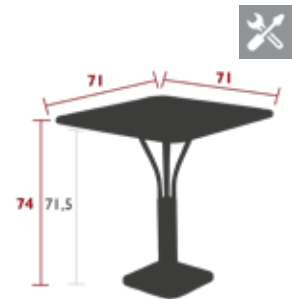

22 kg

4134 - PEDESTAL TABLE 80 X 80 CM  
 DESIGN BY FRÉDÉRIC SOFIA



Aluminium slat table top  
 Tubular aluminium base  
 Aluminium base, steel ballast  
 Parasol hole : pole max. Ø 37 mm

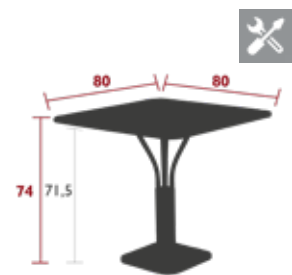

19.6 kg

4135 - FOUR-LEG TABLE 80 X 80 CM  
 DESIGN BY FRÉDÉRIC SOFIA



Aluminium slat table top  
 Tubular aluminium base  
 Parasol hole : pole max. Ø 41 mm  
 Compatible with :  
 Parasol Ø 250 CM - SHADOO

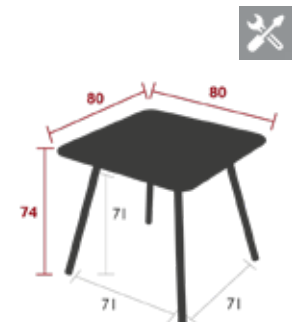

9 kg

4133 - TABLE 143 X 80 CM  
 DESIGN BY FRÉDÉRIC SOFIA



Aluminium slat table top  
 Tubular aluminium base  
 Parasol hole : pole max. Ø 41 mm  
 Compatible with :  
 Parasol Ø 250 CM - SHADOO



13.2 kg

# LUXEMBOURG

# DINING

4136 - TABLE 165 X 100 CM

DESIGN BY FRÉDÉRIC SOFIA

DOMESTIC PROFESSIONAL INTENSIVE

9 IPAC

8

25



Aluminium slat table top  
Tubular aluminium base

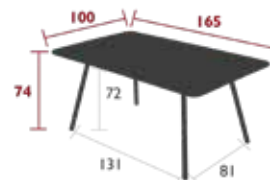

19.4 kg

4132 - TABLE 207 X 100 CM

DESIGN BY FRÉDÉRIC SOFIA

DOMESTIC PROFESSIONAL INTENSIVE

9 IPAC

8

25

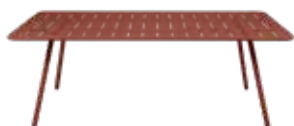

Aluminium slat table top  
Tubular aluminium base

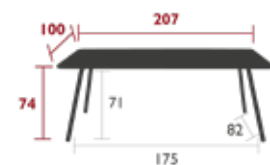

21.4 kg



# LUXEMBOURG

# HIGH DINING

4112 - BAR STOOL  
DESIGN BY FRÉDÉRIC SOFIA

DOMESTIC PROFESSIONAL INTENSIVE 9 IPAC 25



Tubular aluminium frame  
Curved aluminium slat seat  
Silencing pads  
Stacking capacity : x 6 (Height – stacked : 106.5 cm)  
Compatible with :  
OUTDOOR CUSHION 41 X 38 CM - COLOR MIX



3.5 kg



4103 - BAR CHAIR  
DESIGN BY FRÉDÉRIC SOFIA

DOMESTIC PROFESSIONAL INTENSIVE 9 IPAC 25



Tubular aluminium frame  
Curved aluminium slat seat  
Curved aluminium slat backrest  
Silencing pads  
Stacking capacity : x 6 (Height – stacked : 120 cm)  
Compatible with :  
SKIN OUTDOOR CUSHION 45 X 40 CM - BASICS  
OUTDOOR CUSHION 37 X 41 CM - BASICS  
OUTDOOR CUSHION 41 X 38 CM - COLOR MIX



4.9 kg



4113 - HIGH ARMCHAIR  
DESIGN BY FRÉDÉRIC SOFIA

DOMESTIC PROFESSIONAL INTENSIVE 9 IPAC 25



Tubular aluminium frame  
Curved aluminium slat seat  
Curved aluminium slat backrest  
Aluminium slat armrests  
Silencing pads  
Stacking capacity : x 6 (Height – stacked : 123 cm)  
Compatible with :  
SKIN OUTDOOR CUSHION 45 X 40 CM - BASICS  
OUTDOOR CUSHION 37 X 41 CM - BASICS  
ARMREST SHELF - BELLEVIE  
OUTDOOR CUSHION 41 X 38 CM - COLOR MIX



6 kg



4140 - HIGH PEDESTAL TABLE 80 X 80 CM  
DESIGN BY FRÉDÉRIC SOFIA

DOMESTIC PROFESSIONAL INTENSIVE 9 IPAC 25



Aluminium slat table top  
Tubular aluminium base  
Aluminium base, steel ballast  
Parasol hole : pole max. Ø 37 mm

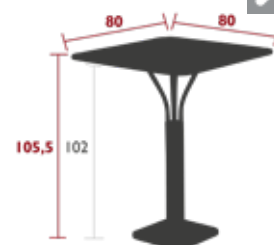

21.5 kg





# LUXEMBOURG

# HIGH DINING

4141 - HIGH TABLE 126 X 73 CM

DESIGN BY FRÉDÉRIC SOFIA

DOMESTIC PROFESSIONAL INTENSIVE

9  
IPAC

6

25



Aluminium slat table top  
Tubular aluminium base  
Tubular aluminium cross-piece for footrest  
Comes with two handbag hooks



16 kg

FURNITURE



LUXEMBOURG, BALAD, CALVI, BALAD & BOUQUET SAUVAGE

# LUXEMBOURG LOUNGE

4166 - ROCKING CHAIR  
DESIGN BY FRÉDÉRIC SOFIA

DOMESTIC PROFESSIONAL INTENSIVE 9 IPAC 25



Tubular aluminium frame  
Curved aluminium slat seat  
Curved aluminium slat backrest  
Aluminium slat armrests  
Delivered assembled

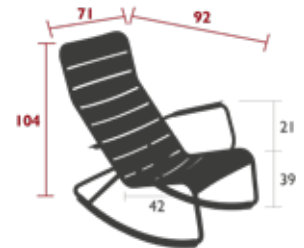

8.4 kg

4211 - LOUNGE CHAIR  
DESIGN BY FRÉDÉRIC SOFIA

DOMESTIC PROFESSIONAL INTENSIVE 9 IPAC 25



Tubular aluminium frame  
Curved aluminium slat seat  
Curved aluminium slat backrest  
Silencing pads  
Stacking capacity : x 6 (Height – stacked : 101 cm)  
Compatible with :  
SET OF 2 OUTDOOR CUSHION 41 X 45 CM - COLOR MIX



4 kg

4212 - LOUNGE ARMCHAIR  
DESIGN BY FRÉDÉRIC SOFIA

DOMESTIC PROFESSIONAL INTENSIVE 9 IPAC 25



Tubular aluminium frame  
Curved aluminium slat seat  
Curved aluminium slat backrest  
Aluminium slat armrests  
Silencing pads  
Stacking capacity : x 6 (Height – stacked : 101 cm)  
Compatible with :  
ARMREST SHELF - BELLEVIE  
SET OF 2 OUTDOOR CUSHION 41 X 45 CM - COLOR MIX

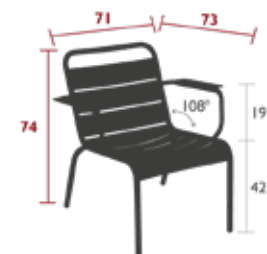

5 kg



LUXEMBOURG, COLOR MIX & ENVIE D'AILLEURS

FURNITURE

# LUXEMBOURG LOUNGE

4104 - LOW ARMCHAIR  
DESIGN BY FRÉDÉRIC SOFIA



Tubular aluminium frame  
Curved aluminium slat seat  
Curved aluminium slat backrest  
Aluminium slat armrests  
Silencing pads  
Stacking capacity : x 6 (Height – stacked : 102 cm)  
Compatible with :  
OUTDOOR CUSHION 96 X 47 CM - BASICS  
SET OF 2 OUTDOOR CUSHION 41 X 45 CM - COLOR MIX  
LOW ARMCHAIR HEADREST - LUXEMBOURG

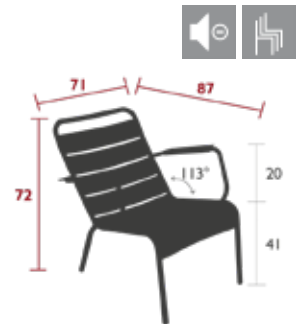

5.9 kg

4165 - LOW ARMCHAIR HEADREST  
DESIGN BY FRÉDÉRIC SOFIA



Tubular aluminium frame  
OTF Batyline® Duo or Stereo outdoor fabric - 100% polyester thread coated in solution-dyed PVC  
Available colours: see limited colour chart  
Compatible with :  
LOW ARMCHAIR - LUXEMBOURG  
STEEL LOW ARMCHAIR - LUXEMBOURG



0.74 kg

4105 - DUO LOW ARMCHAIR  
DESIGN BY FRÉDÉRIC SOFIA



Tubular aluminium frame  
Curved aluminium slat seat  
Curved aluminium slat backrest  
Aluminium slat armrests  
Silencing pads  
Stacking capacity : x 4 (Height – stacked : 85 cm)



11 kg

4116 - 2-SEATER GARDEN BENCH  
DESIGN BY FRÉDÉRIC SOFIA



Tubular aluminium frame  
Curved aluminium slat seat  
Curved aluminium slat backrest  
Aluminium slat armrests  
Silencing pads  
Compatible with :  
ARMREST SHELF - BELLEVIE  
BENCH OUTDOOR CUSHION 106 X 35 CM - COLOR MIX

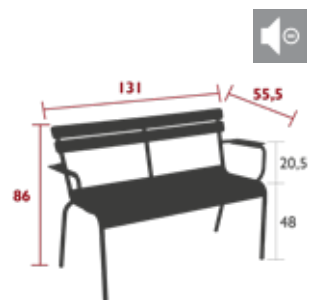

11 kg

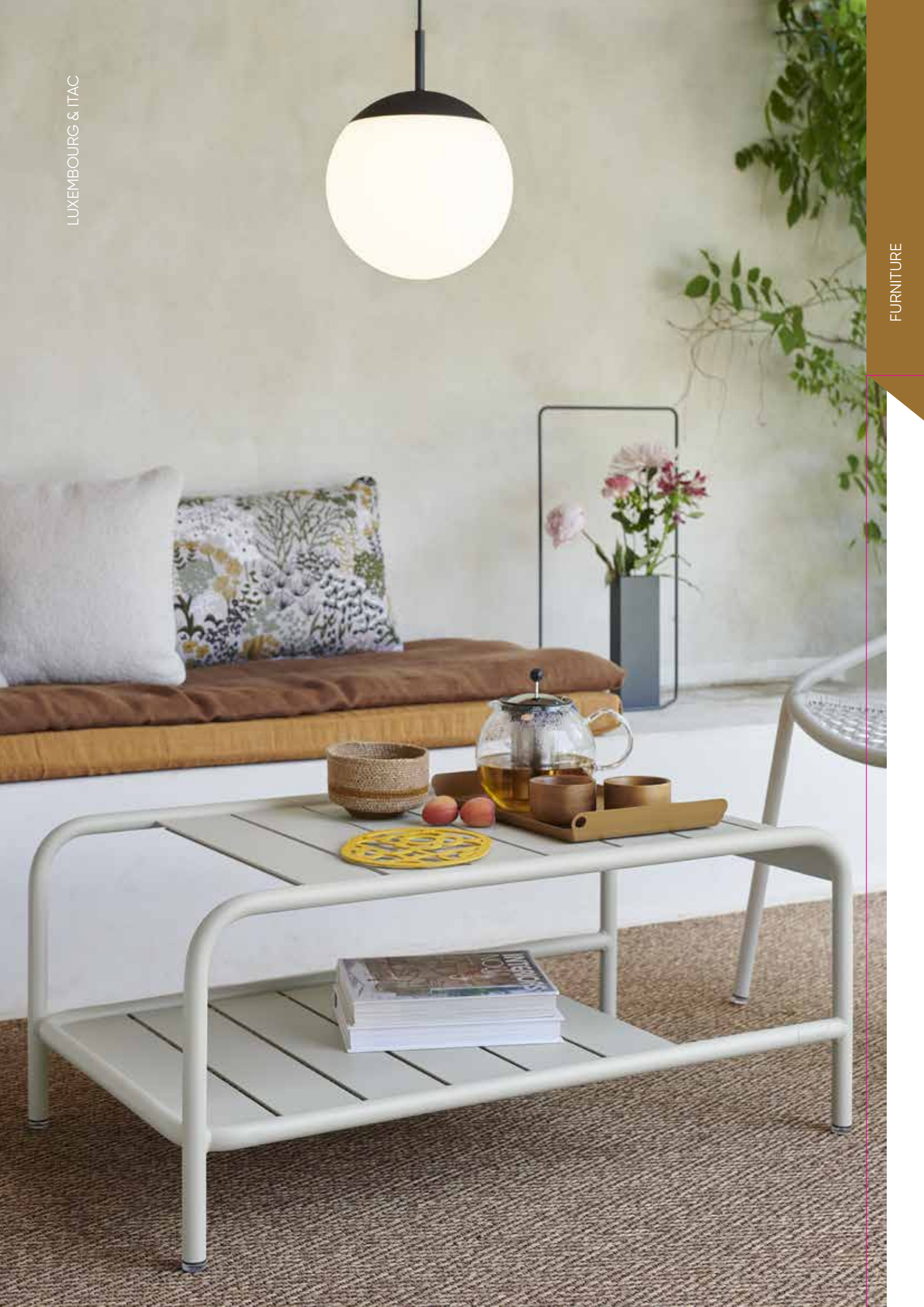

# LUXEMBOURG

# LOUNGE

4160 - SMALL LOW TABLE / FOOTREST 44 X 42 CM  
DESIGN BY FRÉDÉRIC SOFIA



Aluminium slat table top  
Tubular aluminium base  
Silencing pads

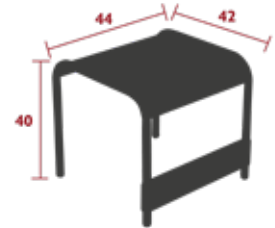

3 kg



4161 - LARGE LOW TABLE / BENCH 86 X 44 CM  
DESIGN BY FRÉDÉRIC SOFIA



Aluminium slat table top  
Tubular aluminium base  
Silencing pads

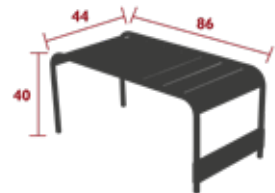

5 kg



4168 - LOW TABLE WITH CASTERS 105 X 72 CM



Aluminium slat table top  
Tubular aluminium base  
Aluminium wheels with flexible PVC tread : Painted aluminium  
Wheel bodies  
Silencing pads

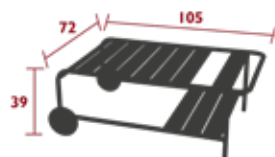

10.6 kg



4169 - LOW TABLE 90 X 55 CM



Aluminium slats table top  
Aluminium tubular base  
Intermediate table top made from aluminium slats  
Silencing pads

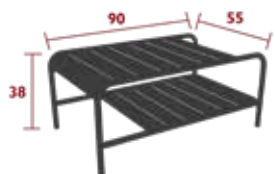

10.6 kg



# LUXEMBOURG STEEL

4121 - STEEL CHAIR  
DESIGN BY FRÉDÉRIC SOFIA



Tubular steel frame  
Curved steel slat seat  
Curved steel slat backrest  
Silencing pads  
Stacking capacity : x 8 (Height – stacked : 118 cm)  
Compatible with :  
SKIN OUTDOOR CUSHION 45 X 40 CM - BASICS  
OUTDOOR CUSHION 37 X 41 CM - BASICS  
OUTDOOR CUSHION 41 X 38 CM - COLOR MIX



10 kg

4122 - STEEL ARMCHAIR  
DESIGN BY FRÉDÉRIC SOFIA



Tubular steel frame  
Curved steel slat seat  
Curved steel slat backrest  
Steel slat armrests  
Silencing pads  
Stacking capacity : x 4 (Height – stacked : 100 cm)  
Compatible with :  
OUTDOOR CUSHION 37 X 41 CM - BASICS  
SKIN OUTDOOR CUSHION 45 X 40 CM - BASICS  
ARMREST SHELF - BELLEVIE  
OUTDOOR CUSHION 41 X 38 CM - COLOR MIX

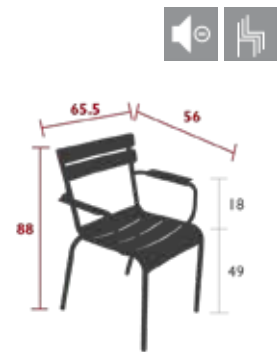

11 kg

4124 - STEEL LOW ARMCHAIR  
DESIGN BY FRÉDÉRIC SOFIA



Tubular steel frame  
Curved steel slat seat  
Curved steel slat backrest  
Steel slat armrests  
Silencing pads  
Stacking capacity : x 4 (Height – stacked : 90 cm)  
Compatible with :  
OUTDOOR CUSHION 96 X 47 CM - BASICS  
SET OF 2 OUTDOOR CUSHION 41 X 45 CM - COLOR MIX  
LOW ARMCHAIR HEADREST - LUXEMBOURG



14.5 kg

4151 - MINIATURE CHAIR (SCALE 1/6)  
DESIGN BY FRÉDÉRIC SOFIA



Steel

415165  Willow green    415101  Cotton White



0.11 kg

# LUXEMBOURG WORK GARDEN OFFICE

4143 - HIGH TABLE 126 X 73 CM

NEW

DOMESTIC PROFESSIONAL INTENSIVE

9  
IPAC

6

25



Aluminium sheet table top  
Aluminium tubular base  
Table top equipped with 2 cup holders  
Tubular aluminium cross-piece for footrest  
Delivered with a trinket tray and two handbag hooks

Compatible with :  
TRINKET TRAY - LUXEMBOURG WORK



21 kg

Watch  
our video



4145 - TRINKET TRAY

NEW

DOMESTIC PROFESSIONAL INTENSIVE

6<sup>7</sup>  
IPAC

25



Steel sheet  
Compatible with :  
HIGH TABLE 126 X 73 CM - LUXEMBOURG WORK  
HIGH TABLE 126 X 73 CM - LUXEMBOURG

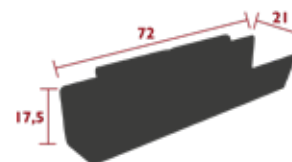

4 kg



# LUXEMBOURG KID

4106 - CHAIR

DOMESTIC PROFESSIONAL INTENSIVE 9 IPAC 25



Tubular aluminium frame  
 Curved aluminium slat seat  
 Curved aluminium slat backrest  
 Suitable for children aged 3-6 years (complies with European standards)  
Stacking capacity : x 3 (Height – stacked : 60 cm)



1.1 kg

4109 - BENCH

DOMESTIC PROFESSIONAL INTENSIVE 9 IPAC 25



Tubular aluminium frame  
 Curved aluminium slat seat  
 Curved aluminium slat backrest  
 Suitable for children aged 3-6 years (complies with European standards)  
Stacking capacity : x 3 (Height – stacked : 60 cm)



2.8 kg

4170 - TABLE 57 X 57 CM

DOMESTIC PROFESSIONAL INTENSIVE 8 IPAC 25



Steel sheet table top  
 Tubular steel base  
 Aluminium frame beneath table top  
 Silencing pads

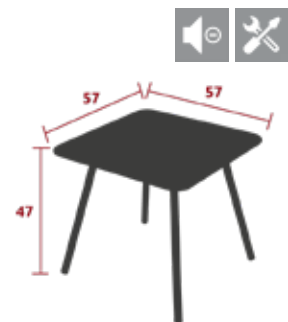

7 kg

4171 - TABLE 76 X 55.5 CM

DOMESTIC PROFESSIONAL INTENSIVE 8 IPAC 25



Steel sheet table top  
 Tubular steel base  
 Aluminium frame beneath table top  
 Silencing pads



8.5 kg

# MONCEAU DINING

## CONTRACT EXCLUSIVITY

4805 - STOOL

DESIGN BY STUDIO FERMOB

DOMESTIC PROFESSIONAL INTENSIVE

6  
IPAC



Tubular steel frame  
Steel slat seat  
Silencing pads  
Stacking capacity : x 11 (Height – stacked : 140 cm)  
Available colours: see limited colour chart  
Compatible with :  
OUTDOOR CUSHION 41 X 38 CM - COLOR MIX



5.1 kg

4803 - ARMCHAIR

DESIGN BY STUDIO FERMOB

DOMESTIC PROFESSIONAL INTENSIVE

6  
IPAC



Tubular steel frame  
Steel slat seat  
Steel slat backrest  
Tubular steel armrests  
Silencing pads  
Stacking capacity : x 10 (Height – stacked : 150 cm)  
Available colours: see limited colour chart  
Compatible with :  
OUTDOOR CUSHION 41 X 38 CM - COLOR MIX



6.4 kg

4802 - XL ARMCHAIR

DESIGN BY STUDIO FERMOB

DOMESTIC PROFESSIONAL INTENSIVE

6  
IPAC



Tubular steel frame  
Steel slat seat  
Steel slat backrest  
Steel slat armrests  
Silencing pads  
Stacking capacity : x 10 (Height – stacked : 150 cm)  
Available colours: see limited colour chart  
Compatible with :  
OUTDOOR CUSHION 41 X 38 CM - COLOR MIX

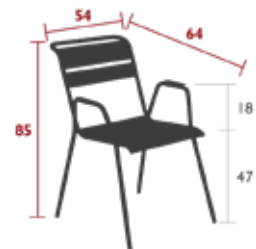

7.5 kg

# MONCEAU DINING

## CONTRACT EXCLUSIVITY

4810 - 2/3-SEATER BENCH

DESIGN BY STUDIO FERMOB

DOMESTIC PROFESSIONAL INTENSIVE

6  
IPAC



Tubular steel frame  
Steel slat seat  
Steel slat backrest  
Silencing pads  
Stacking capacity : x 10 (Height – stacked : 145 cm)  
Available colours: see limited colour chart  
Compatible with :  
BENCH OUTDOOR CUSHION 106 X 35 CM - COLOR MIX

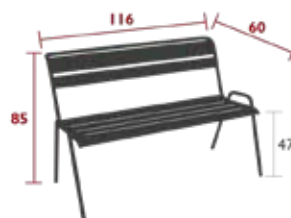

17 kg



4811 - 3/4-SEATER BENCH

DESIGN BY STUDIO FERMOB

DOMESTIC PROFESSIONAL INTENSIVE

7  
IPAC



Tubular steel frame  
Steel slat seat  
Silencing pads  
Available colours: see limited colour chart

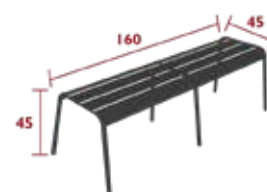

14.5 kg



4831 - TABLE 146 X 80 CM

DESIGN BY STUDIO FERMOB

DOMESTIC PROFESSIONAL INTENSIVE

7  
IPAC



Perforated steel sheet table top  
Tubular steel base  
Available colours: see limited colour chart  
Compatible with :  
PROTECTIVE COVER 160 X 100 CM FOR TABLE - COVERS

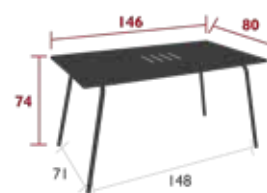

25.5 kg



4832 - TABLE 194 X 94 CM

DESIGN BY STUDIO FERMOB

DOMESTIC PROFESSIONAL INTENSIVE

7  
IPAC



Perforated steel sheet table top  
Tubular steel base  
Available colours: see limited colour chart  
Compatible with :  
PROTECTIVE COVER 210 X 100 FOR TABLE - COVERS



41 kg



MONCEAU, APLÔ, ALTO & JOS



MONCEAU, OULALA & BALAD



# MONCEAU LOUNGE

## CONTRACT EXCLUSIVITY

4806 - ROCKING CHAIR

DESIGN BY STUDIO FERMOB

DOMESTIC PROFESSIONAL INTENSIVE 6 IPAC 17



Tubular steel frame  
Steel slat seat  
Steel slat backrest  
Tubular steel armrest  
Available colours: see limited colour chart  
Compatible with :  
SET OF 2 OUTDOOR CUSHION 41 X 45 CM - COLOR MIX



11 kg

4804 - LOW ARMCHAIR

DESIGN BY STUDIO FERMOB

DOMESTIC PROFESSIONAL INTENSIVE 6 IPAC 17



Tubular steel frame  
Steel slat seat  
Steel slat backrest  
Tubular steel armrest  
Silencing pads  
Stacking capacity : x 10 (Height – stacked : 137 cm)  
Available colours: see limited colour chart  
Compatible with :  
SET OF 2 OUTDOOR CUSHION 41 X 45 CM - COLOR MIX



8.6 kg

4840 - FOOTREST

DESIGN BY STUDIO FERMOB

DOMESTIC PROFESSIONAL INTENSIVE 6 IPAC 17



Sleet slat  
Tubular steel base  
Silencing pads  
Stacking capacity : x 10 (Height – stacked : 144 cm)  
Available colours: see limited colour chart

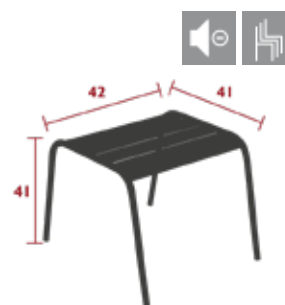

3.8 kg

4841 - LOW TABLE 57 X 57 CM

DESIGN BY STUDIO FERMOB

DOMESTIC PROFESSIONAL INTENSIVE 7 IPAC 17



Perforated steel sheet table top  
Tubular steel base  
Silencing pads  
Available colours: see limited colour chart

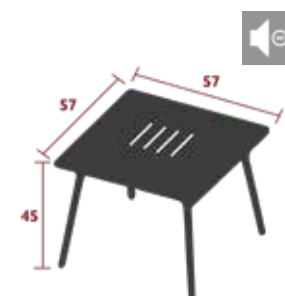

6 kg

# MONTMARTRE

4601 - CHAIR

DOMESTIC | PROFESSIONAL | INTENSIVE

6<sup>7</sup>  
IPAC



Steel wire frame  
 Perforated steel sheet seat  
 Steel wire backrest  
Stacking capacity : x 10 (Height – stacked : 160 cm)  
 Available colours: see limited colour chart  
Compatible with :  
 OUTDOOR CUSHION Ø 39 CM - BASICS  
 OUTDOOR CUSHION Ø 40 CM - COLOR MIX



6 kg

4602 - ARMCHAIR

DOMESTIC | PROFESSIONAL | INTENSIVE

6<sup>7</sup>  
IPAC



Steel wire frame  
 Perforated steel sheet seat  
 Steel wire backrest  
 Steel wire armrests  
Stacking capacity : x 7 (Height – stacked : 135 cm)  
 Available colours: see limited colour chart  
Compatible with :  
 OUTDOOR CUSHION Ø 43 CM - BASICS

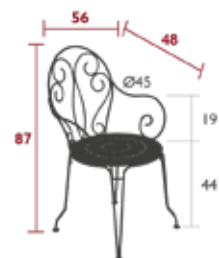

7.3 kg

1060 - PORTABLE BAR

DOMESTIC | PROFESSIONAL | INTENSIVE

6<sup>7</sup>  
IPAC



Steel wire frame  
 Perforated steel sheet table top  
 Available colours: see limited colour chart



4.5 kg

# MONTMARTRE

0630 - TABLE Ø 96 CM

DOMESTIC PROFESSIONAL INTENSIVE

6<sup>7</sup>  
IPAC

2 x 5



Perforated steel sheet table top  
Tubular and wire steel base  
Parasol hole : pole max. Ø 39 mm  
Available colours: see limited colour chart

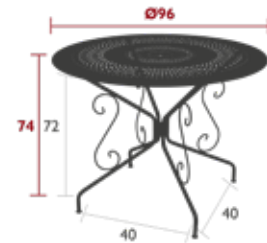

10.5 kg

0631 - TABLE Ø 117 CM

DOMESTIC PROFESSIONAL INTENSIVE

6<sup>7</sup>  
IPAC

2 x 6



Perforated steel sheet table top  
Tubular and wire steel base  
Parasol hole : pole max. Ø 39 mm  
Available colours: see limited colour chart



14.2 kg

MONTMARTRE, PICOLINO & TRÉFLE



# NEVADO

3219 - LOG HOLDER  
DESIGN BY STUDIO FERMOB

DOMESTIC PROFESSIONAL INTENSIVE

6  
IPAC



Flat steel frame  
Removable steel sheet shelf  
Available colour : see limited colour chart

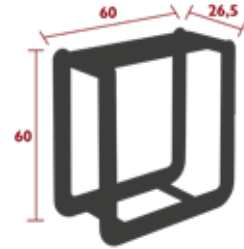

11 kg



NEVADO



# OPÉRA+

0911 - CHAIR

DESIGN BY STUDIO FERMOB



Steel wire frame  
 Steel sheet seat  
 Steel wire backrest  
Stacking capacity : x 10 (Height – stacked : 180 cm)  
Compatible with :  
 OUTDOOR CUSHION Ø 39 CM - BASICS  
 OUTDOOR CUSHION Ø 40 CM - COLOR MIX



5.7 kg

0912 - ARMCHAIR

DESIGN BY STUDIO FERMOB



Steel wire frame  
 Steel sheet seat  
 Steel wire backrest  
 Steel wire armrests  
Stacking capacity : x 4 (Height – stacked : 120 cm)  
Compatible with :  
 OUTDOOR CUSHION Ø 39 CM - BASICS  
 OUTDOOR CUSHION Ø 40 CM - COLOR MIX



5.9 kg

0949 - TABLE Ø 67 CM

DESIGN BY STUDIO FERMOB



Steel sheet table top  
 Tubular steel base  
 Flat steel belt  
 Fastening system between the table top and the base  
 Fastening system between the base and the belt



7.6 kg

0948 - TABLE Ø 96 CM

DESIGN BY STUDIO FERMOB



Steel sheet table top  
 Tubular steel base  
 Parasol hole : pole max. Ø 40 mm  
 Flat steel belt  
 Fastening system between the table top and the base  
 Fastening system between the base and the belt  
Compatible with :  
 Parasol Ø 250 CM - SHADOO



10.6 kg

# OPÉRA+

0950 - TABLE Ø 117 CM  
DESIGN BY STUDIO FERMOB

DOMESTIC PROFESSIONAL INTENSIVE

6<sup>7</sup>  
IPAC

1 x 6

25



Steel sheet table top  
Tubular steel base  
Parasol hole : pole max. Ø 40 mm  
Flat steel belt  
Fastening system between the table top and the base  
Fastening system between the base and the belt  
Set of 2 leg risers provided for rain runoff  
Compatible with :  
Parasol Ø 250 CM - SHADOO



16.4 kg

0946 - CARRONDE TABLE 82 X 82 CM  
DESIGN BY STUDIO FERMOB

DOMESTIC PROFESSIONAL INTENSIVE

6<sup>7</sup>  
IPAC

1 x 4

25



Steel sheet table top  
Tubular steel base  
Flat steel belt  
Fastening system between the table top and the base  
Fastening system between the base and the belt

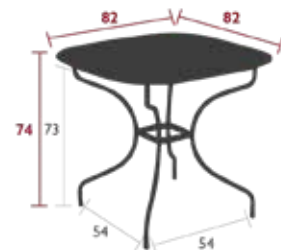

12.5 kg

0947 - OVAL TABLE 160 X 90 CM  
DESIGN BY STUDIO FERMOB

DOMESTIC PROFESSIONAL INTENSIVE

6<sup>7</sup>  
IPAC

1 x 6

25



Steel sheet table top  
Tubular steel base  
Flat steel belt  
Fastening system between the table top and the base  
Fastening system between the base and the belt  
Set of 2 leg risers provided for rain runoff  
Compatible with :  
PROTECTIVE COVER 160 X 100 CM FOR TABLE - COVERS

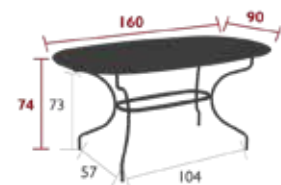

27.5 kg



# OULALA

9009 - SET OF 3 NESTING LOW TABLES

DESIGN BY STUDIO FERMOB

DOMESTIC PROFESSIONAL INTENSIVE

6<sup>7</sup>  
IPAC



Steel sheet table top  
Steel wire base  
Available colours: see limited colour chart

900907 ●●● Rosemary / Cactus / Clay Grey = Summer romance  
900905 ●●● Black Cherry / Red ochre / Chili = Solar power  
900906 ●●● Acapulco Blue / Ice mint / Storm Grey = New horizons

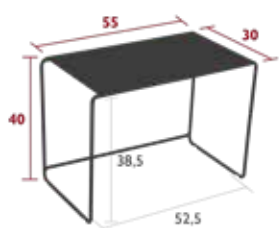

3.7 kg

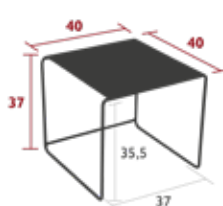

3.5 kg



3.6 kg

10.8 kg



OULALA, ALTO & APLÓ

Up to 1.2m long!  
Ideal as a coffee table for entertaining.



OULALA

Original composition,  
to accompany a lounge set.

Clever composition,  
perfect for the end of a sofa.



# ORIGAMI

1015 - BENCH

DESIGN BY HARALD GUGGENBICHLER

DOMESTIC PROFESSIONAL INTENSIVE

7<sup>9</sup>  
IPAC



Steel sheet Frame  
Steel sheet seat

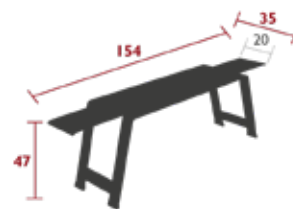

37.5 kg



ORIGAMI, ÉVASION & ITAC

# PASAIA

3200 - SHOWER

DESIGN BY MERMELADA ESTUDIO



Tubular aluminium frame  
"Rainwater effect" shower head  
Connected to your garden hose using an adapter  
Grate with aluminium frame and wood-finish PVC slats  
Jack system to ensure the shower is stable and completely flat  
Available colours: see limited colour chart



23.5 kg

# PÉTALE

7238 - TABLE 60 X 70 CM  
DESIGN BY PHILIPPE MATHIEU

DOMESTIC PROFESSIONAL INTENSIVE

6<sup>7</sup>  
IPAC



Steel sheet table top  
Tubular steel base  
Tilting, tables nest for storage  
Steel flap handle for opening/closing the table top  
Silencing pads



18.2 kg

7237 - TABLE 110 X 70 CM  
DESIGN BY PHILIPPE MATHIEU

DOMESTIC PROFESSIONAL INTENSIVE

6<sup>7</sup>  
IPAC



Steel sheet table top  
Tubular steel base  
Tilting, tables nest for storage  
Steel flap handle for opening/closing the table top  
Silencing pads  
Table delivered assembled



20.2 kg



# PIAPOLO

3206 - STOOL

DESIGN BY TRISTAN LOHNER

NEW

DOMESTIC PROFESSIONAL INTENSIVE

10 IPAC



Aluminium sheet frame  
Aluminium sheet seat  
Upper bowl can be used as a storage compartment  
Concealed drain hole at the bottom of the upper bowl  
Soundproofed pads and lid  
Available colours: see limited colour chart

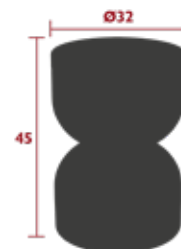

4.4 kg

FURNITURE



PIAPOLO, LUXEMBOURG & BALAD

# PICOLINO

3249 - PLANT HOLDER H.63 CM  
 DESIGN BY STUDIO FERMOB

NEW DOMESTIC PROFESSIONAL INTENSIVE 6<sup>8</sup> IPAC 25



Steel wire frame  
 Steel sheet shelf



9.7 kg

3281 - WALL SHELF  
 DESIGN BY STUDIO FERMOB

NEW DOMESTIC PROFESSIONAL INTENSIVE 6<sup>7</sup> IPAC 25



Steel wire frame  
 Steel sheet shelf  
 2 hooks at either end to hang a variety of objects  
 Wall mounting (screws not supplied)

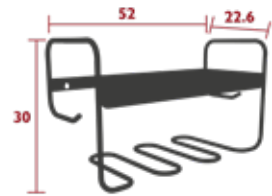

4.1 kg



PICOLINO



PICOLINO & IOS

# PLEIN AIR

8301 - CHAIR

DESIGN BY PASCAL MOURGUE

DOMESTIC PROFESSIONAL INTENSIVE

7  
IPAC



Tubular steel frame  
Duo or Stereo OTF Batyline® outdoor fabric seat - high-tenacity 100% polyester thread coated in solution-dyed PVC  
Duo or Stereo OTF Batyline® outdoor fabric backrest - high-tenacity 100% polyester thread coated in solution-dyed PVC  
Available colours: see limited colour chart

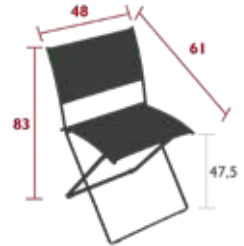

4.3 kg

8303 - ARMCHAIR

DESIGN BY PASCAL MOURGUE

DOMESTIC PROFESSIONAL INTENSIVE

7  
IPAC



Tubular steel frame  
Duo or Stereo OTF Batyline® outdoor fabric seat - high-tenacity 100% polyester thread coated in solution-dyed PVC  
Duo or Stereo OTF Batyline® outdoor fabric backrest - high-tenacity 100% polyester thread coated in solution-dyed PVC  
Moulded aluminium armrests  
Available colours: see limited colour chart

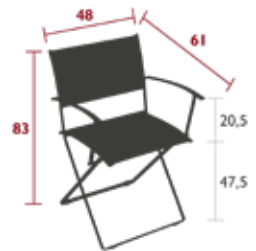

4.8 kg



PLEIN AIR & CARACTERE

# QUIBERON

3210 - SIDE BAR/TROLLEY  
DESIGN BY STUDIO FERMOB

DOMESTIC PROFESSIONAL INTENSIVE

7  
IPAC



Tubular aluminium frame  
Perforated steel sheet table top  
Integrated wheels

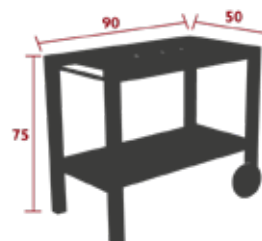

16 kg



QUIBERON

# REST'O

8810 - TABLE Ø 60 CM  
DESIGN BY TRISTAN LOHNER

DOMESTIC | PROFESSIONAL | INTENSIVE

9  
IPAC

2

25



Steel sheet table top  
Tubular aluminium base  
Steel internal rod  
Tilting, tables nest for storage  
Aluminium flap handle to open/close the table top  
Protective stoppers to fit table tops safely with no risk of «denting»  
Height-adjustable pads

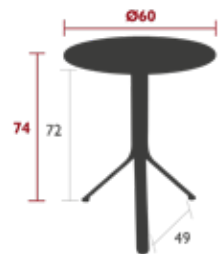

7.5 kg

8813 - TABLE 57 X 57 CM  
DESIGN BY TRISTAN LOHNER

DOMESTIC | PROFESSIONAL | INTENSIVE

9  
IPAC

2

25



Steel sheet table top  
Tubular aluminium base  
Steel internal rod  
Tilting, tables nest for storage  
Aluminium flap handle to open/close the table top  
Protective stoppers to fit table tops safely with no risk of denting  
Height-adjustable pads

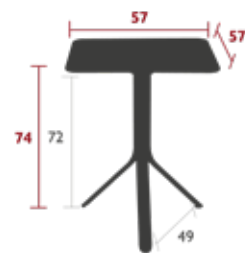

7.8 kg



RESTO & CADIZ

# RIBAMBELLE

5221 - TABLE WITH 2 EXTENSIONS 149/234 X 100 CM

DESIGN BY STUDIO FERMOB

DOMESTIC PROFESSIONAL INTENSIVE

10  
IPAC

10

25



Aluminium sheet table top  
Tubular aluminium base  
Telescopic system with stainless steel bearing mechanism  
Extension storage compartment under the table top  
Set of 2 leg risers provided for rain runoff

Compatible with :

PROTECTIVE COVER 160 X 100 CM FOR TABLE - COVERS

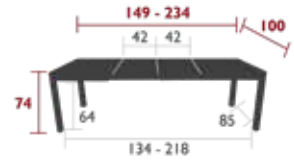

41.2 kg

5222 - TABLE WITH 3 EXTENSIONS XL 149/299 X 100 CM

DESIGN BY STUDIO FERMOB

DOMESTIC PROFESSIONAL INTENSIVE

10  
IPAC

10

25



Aluminium sheet table top  
Tubular aluminium base  
Telescopic system with stainless steel bearing mechanism  
Extension storage compartment under the table top  
Set of 2 leg risers provided for rain runoff

Compatible with :

PROTECTIVE COVER 160 X 100 CM FOR TABLE - COVERS

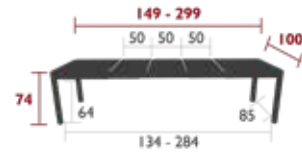

50.4 kg



# ROMANE

2131 - TABLE Ø 137 CM

DOMESTIC PROFESSIONAL INTENSIVE

7 IPAC

8

25



Steel sheet table top  
 Tubular steel base  
 Flat iron belt  
 Set of 2 leg risers provided for rain runoff  
 Height-adjustable pads

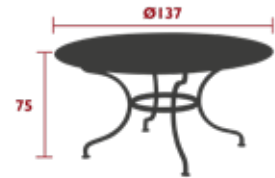

51 kg

2134 - TABLE 180 X 100 CM

DOMESTIC PROFESSIONAL INTENSIVE

8 IPAC

10

25



Steel sheet table top  
 Tubular steel base  
 Flat iron belt  
 Height-adjustable pads  
 Set of 2 leg risers provided for rain runoff  
 Compatible with :  
 PROTECTIVE COVER 210 X 100 FOR TABLE - COVERS

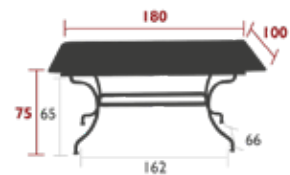

61 kg

2138 - TABLE WITH EXTENSIONS 200/300 X 100 CM

DOMESTIC PROFESSIONAL INTENSIVE

8 IPAC

14

25



Steel sheet table top  
 Tubular steel base  
 Flat iron belt  
 Height-adjustable pads  
 Set of 2 leg risers provided for rain runoff  
 Compatible with :  
 PROTECTIVE COVER 210 X 100 FOR TABLE - COVERS

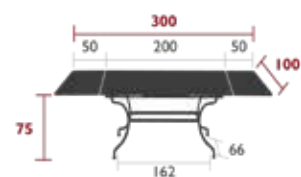

100 kg



# RYTHMIC

4402 - ARMCHAIR  
DESIGN BY ARCHIRIVOLTO

DOMESTIC PROFESSIONAL INTENSIVE

7  
IPAC



Tubular steel frame  
Steel sheet seat  
Steel slat backrest  
Steel slat armrest  
Silencing pads  
Stacking capacity : x 5 (Height – stacked : 86 cm)

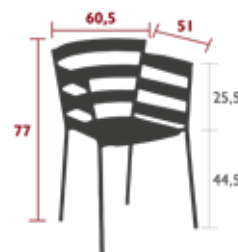

6.5 kg



# SALSA

3270 - PEDESTAL TABLE  
DESIGN BY GOULA & FIGUERA



Steel sheet table top  
Tubular steel base  
Perforated sheet steel basket  
Silencing pads



8 kg

3271 - LOW TABLE | 113 X 58 CM  
DESIGN BY GOULA & FIGUERA



Steel sheet table top  
Tubular steel base  
Perforated sheet steel basket  
Silencing pads

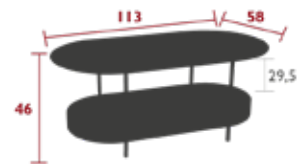

22.5 kg



SALSA & ÉVASION

# SIXTIES

## 1701 - CHAIR

DESIGN BY FRÉDÉRIC SOFIA

DOMESTIC | PROFESSIONAL | INTENSIVE

10 IPAC



Tubular aluminium frame  
 Outdoor fibre polyethylene woven seat  
 Outdoor fibre polyethylene woven backrest  
 Available colours : see limited colour chart



2.5 kg

## 1702 - STACKABLE CHAIR

DESIGN BY FRÉDÉRIC SOFIA

NEW

DOMESTIC | PROFESSIONAL | INTENSIVE

6 IPAC



Tubular steel frame  
 Outdoor fibre polyethylene woven seat  
 Outdoor fibre polyethylene woven backrest  
 Stacking capacity : x 4 (height-stacked : 120 cm)  
 Available colours : see limited colour chart



6,8 kg

## 1704 - ARMCHAIR

DESIGN BY FRÉDÉRIC SOFIA

DOMESTIC | PROFESSIONAL | INTENSIVE

10 IPAC



Tubular aluminium frame  
 Outdoor fibre polyethylene woven seat  
 Outdoor fibre polyethylene woven backrest  
 Available colours : see limited colour chart



4.4 kg

## 1706 - ROCKING CHAIR

DESIGN BY FRÉDÉRIC SOFIA

DOMESTIC | PROFESSIONAL | INTENSIVE

10 IPAC



Tubular aluminium frame  
 Outdoor fibre polyethylene woven seat  
 Outdoor fibre polyethylene woven backrest  
 Available colours : see limited colour chart



4 kg

# SIXTIES

1705 - BENCH  
DESIGN BY FRÉDÉRIC SOFIA

DOMESTIC PROFESSIONAL INTENSIVE

10 IPAC

4



Tubular aluminium frame  
Outdoor fibre polyethylene woven seat  
Outdoor fibre polyethylene woven backrest  
Available colours : see limited colour chart



6.7 kg

1721 - LOW TABLE 76 X 55.5 CM  
DESIGN BY FRÉDÉRIC SOFIA

DOMESTIC PROFESSIONAL INTENSIVE

8 IPAC

25



Steel sheet table top  
Tubular steel base  
Aluminium frame beneath table top



7 kg



SOMERSET & BEBOP



FURNITURE

SOMERSET





- Aluminium frame - light, solid and easy to maintain - available in the 5 colours of the Fermob colour chart,
- Sunbrella® fabric developed exclusively for Fermob by Dickson company, the outdoor fabric specialist. Available in 5 exclusive colours :



CUSHION COVERS DESIGNED FOR OUTDOOR USE

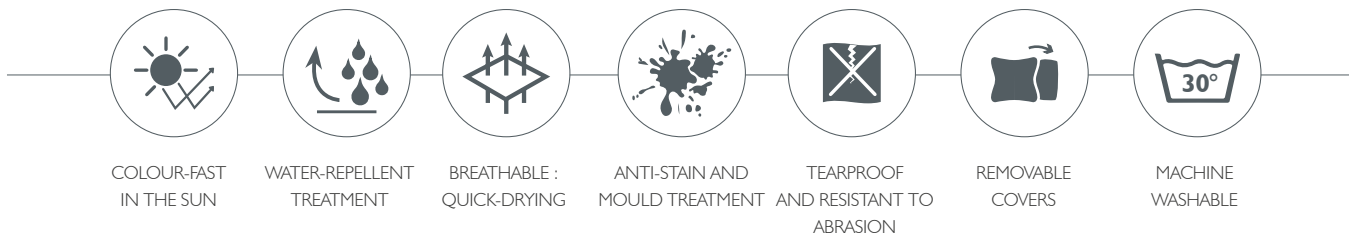

⚠ Must be brought inside during bad weather.

FILLING : HIGH-RESILIENCE POLYURETHANE FOAM

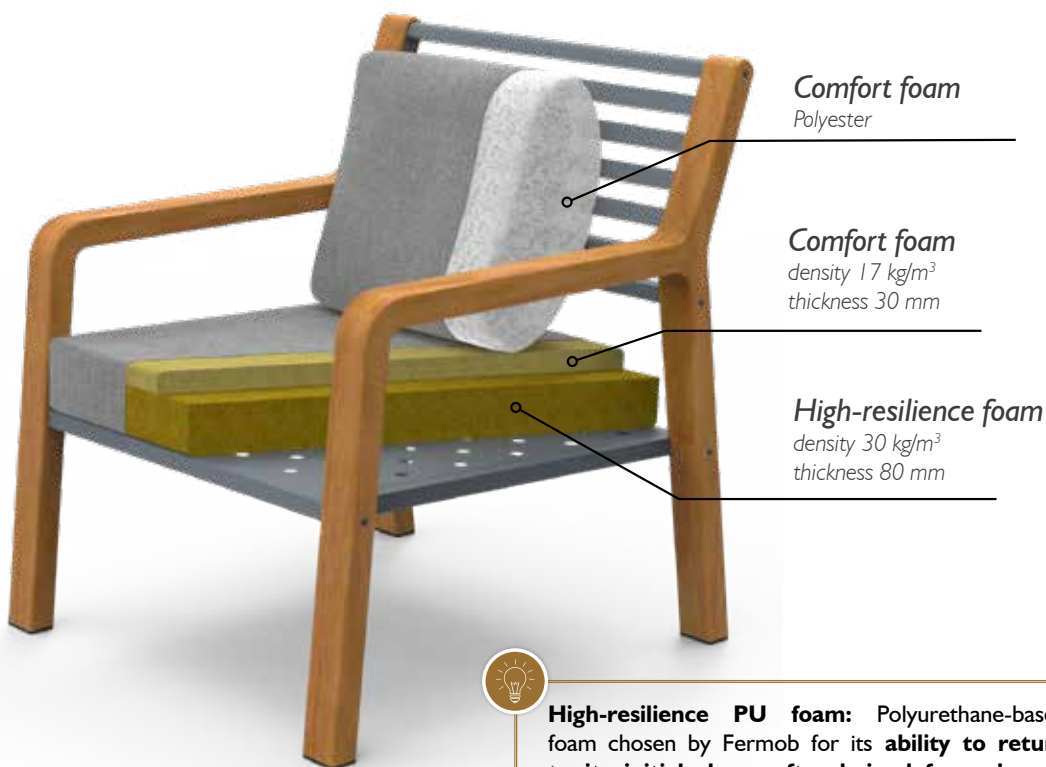

**High-resilience PU foam:** Polyurethane-based foam chosen by Fermob for its **ability to return to its initial shape after being deformed**, even after a long period of use.

# SOMERSET

3237 - BENCH

DESIGN BY STUDIO FERMOB

DOMESTIC PROFESSIONAL INTENSIVE 10 IPAC 25



Teak frame  
Tubular aluminium seat  
Tubular aluminium backrest  
Teak armrest

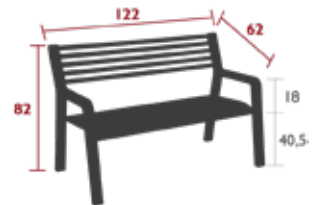

18.8 kg

3232 - ARMCHAIR

DESIGN BY STUDIO FERMOB

NEW DOMESTIC PROFESSIONAL INTENSIVE 10 IPAC 5



Teak frame  
Perforated aluminium sheet seat  
Tubular aluminium backrest  
Teak armrest  
Available colours: see limited colour chart

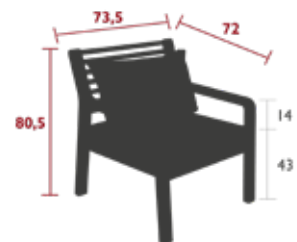

12 kg

3235 - 2-SEATER SOFA

DESIGN BY STUDIO FERMOB

NEW DOMESTIC PROFESSIONAL INTENSIVE 10 IPAC 5



Teak frame  
Perforated aluminium sheet seat  
Tubular aluminium backrest  
Teak armrest  
Available colours: see limited colour chart



25 kg

# SO'O

3261 - TABLE Ø 117 CM  
DESIGN BY STUDIO FERMOB

NEW

DOMESTIC | PROFESSIONAL | INTENSIVE

6  
IPAC

6  
x 6

25



Steel sheet table top  
Tubular steel base  
Supporting cross-beam under the table top  
Set of 2 leg risers provided for rain runoff



27.4 kg



SO'O & STUDIO



# STRIPE

3260 - CHAIR

DESIGN BY MATALI CRASSET

DOMESTIC PROFESSIONAL INTENSIVE

10  
IPAC



Tubular aluminium frame  
Curved aluminium slat seat  
Curved aluminium slat backrest  
Handle on the back of the backrest for ease of handling  
Silencing pads  
Stacking capacity : x 8 (Height – stacked : 110 cm)

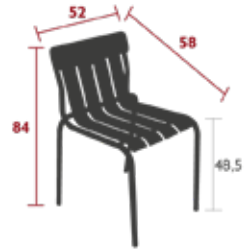

4.9 kg



STRIPE



STRIPE & LUXEMBOURG

# STUDIE

6911 - CHAIR  
DESIGN BY TRISTAN LOHNER



reddot winner 2022  
best of the best



Tubular aluminium frame  
Curved aluminium sheet seat  
Curved aluminium sheet backrest  
Silencing pads  
Stacking capacity : x 8 (Height – stacked : 120 cm)



5.9 kg



6912 - ARMCHAIR  
DESIGN BY TRISTAN LOHNER



Tubular aluminium frame  
Curved aluminium sheet seat  
Curved aluminium sheet backrest  
Tubular aluminium armrest  
Silencing pads  
Stacking capacity : x 6 (Height – stacked : 108 cm)

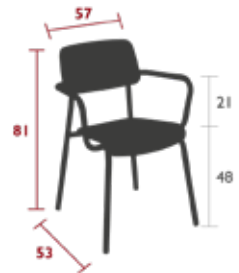

6.4 kg



STUDIE & SOO



# STUDIE

6921 - OAK CHAIR  
DESIGN BY TRISTAN LOHNER



Tubular aluminium frame  
Shaped wooden seat - natural oak finish  
Shaped wooden backrest- natural oak finish  
Silencing pads  
Stacking capacity : x 3 (Height – stacked : 93 cm)



4 kg

6922 - OAK ARMCHAIR  
DESIGN BY TRISTAN LOHNER



Tubular aluminium frame  
Shaped wooden seat - natural oak finish  
Shaped wooden backrest- natural oak finish  
Tubular aluminium armrest  
Silencing pads  
Stacking capacity : x 3 (Height – stacked : 93 cm)

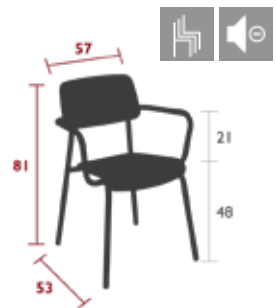

4,5 kg



# SURPRISING DINING

1225 - CHAIR

DESIGN BY HARALD GUGGENBICHLER

DOMESTIC PROFESSIONAL INTENSIVE

7  
IPAC



Steel wire frame  
Perforated steel sheet seat  
Perforated steel sheet backrest  
Stacking capacity : x 10 (Height – stacked : 95 cm)

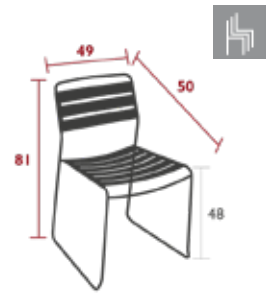

7 kg

1240 - TEAK CHAIR

DESIGN BY HARALD GUGGENBICHLER

DOMESTIC PROFESSIONAL INTENSIVE

7<sup>9</sup>  
IPAC



Steel wire frame  
Teak slat seat  
Teak slat backrest  
Stacking capacity : x 7 (Height – stacked : 101 cm)



7.5 kg



# SURPRISING LOUNGE

1217 - LOW ARMCHAIR

DESIGN BY HARALD GUGGENBICHLER

DOMESTIC PROFESSIONAL INTENSIVE

7 IPAC



Steel wire frame  
Perforated steel sheet seat  
Perforated steel sheet backrest  
Steel wire armrests



10.5 kg

1218 - FOOTREST

DESIGN BY HARALD GUGGENBICHLER

DOMESTIC PROFESSIONAL INTENSIVE

7 IPAC



Steel wire base  
Perforated steel sheet  
Slides away under the low armchair

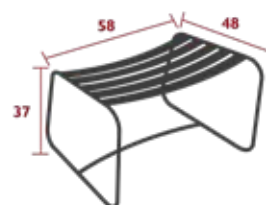

5.7 kg

1244 - TEAK LOW ARMCHAIR

DESIGN BY HARALD GUGGENBICHLER

DOMESTIC PROFESSIONAL INTENSIVE

7<sup>9</sup> IPAC



Steel wire frame  
Teak slat seat  
Teak slat backrest  
Steel wire armrests



10.3 kg

1245 - TEAK FOOTREST

DESIGN BY HARALD GUGGENBICHLER

DOMESTIC PROFESSIONAL INTENSIVE

7<sup>9</sup> IPAC



Teak slat  
Steel wire base

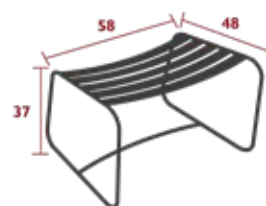

5 kg

# SURPRISING

1228 - ROCKING CHAIR

DESIGN BY HARALD GUGGENBICHLER

NEW

DOMESTIC PROFESSIONAL INTENSIVE

7 IPAC



- Steel wire frame
- Steel slat seat
- Steel slat backrest
- Teak armrests
- Teak base



8.28 kg



# SURPRISING

I260 - LEATHER LOW ARMCHAIR  
DESIGN BY HARALD GUGGENBICHLER



Steel wire frame  
Leather seat  
Leather backrest  
Steel wire armrests  
Available colours: see limited colour chart

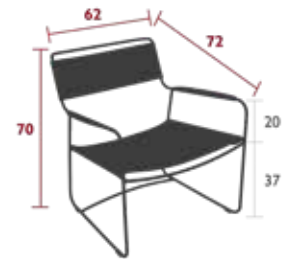

10,5 kg

I261 - LEATHER FOOTREST  
DESIGN BY HARALD GUGGENBICHLER



Steel wire base  
Leather  
Slides away under the leather low armchair  
Available colours: see limited colour chart

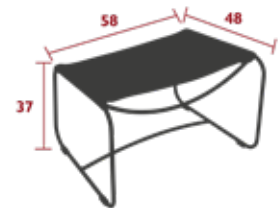

5 kg



The Surprising leather is a very strong, full-grain leather that will last incredibly well over the years. The leather undergoes vegetable tanning, a natural, environmentally friendly process, before being solution-dyed to ensure a clean rear surface and coloured edges, indicating excellent quality. A Scotchgard finish confers impermeability and protects the leather against stains and ageing



SURPRISING, PIPOLINO & MOOONI!

# TERRAZZA

## 3251 - MEDIUM PLANTER DESIGN BY ARCHIRIVOLTO



Tubular steel frame  
Steel sheet tray and shelf  
Tray drainage hole with offset drainage system  
Feet and trays separable  
Available colours : see limited colour chart

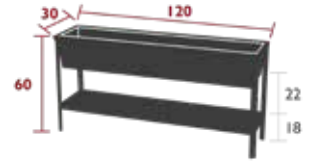

VOL.: 56,5 L

29 kg

## 3250 - LARGE PLANTER DESIGN BY ARCHIRIVOLTO



Tubular steel frame  
Steel sheet tray and shelf  
Tray drainage hole with offset drainage system  
Feet and trays separable  
Available colours : see limited colour chart



VOL.: 56,5 L

31 kg



TERRAZZA



# ULTRASOFA

6250 - LOW TABLE 162 X 74 CM  
DESIGN BY FRÉDÉRIC SOFIA

DOMESTIC PROFESSIONAL INTENSIVE

7  
IPAC



Aluminium sheet table top  
Tubular steel base



15 kg



ULTRASOFA & SURPRISING

FURNITURE

# PARASOLS & ACCESSORIES' COLLECTIONS

Fermob has harnessed all of its outdoor expertise and audacious attitude to bring you a comprehensive **product range for outdoor spaces**. Over five years ago, the brand launched a series of **collections of decorative accessories and outdoor fabrics** – trays, trivets, decorative cushions, round cushions for chairs, fouta towels, garden ponchos, and more – that complement its core product range and are **specially designed for outdoor living**. Now, the brand is going even further as it looks to cement its unique brand positioning. Drawing on the **know-how of Vlaemyck**, a French supplier of parasols and outdoor furniture to the hotel and restaurant industry, Fermob has added a **brand-new type of product** to its range: **parasols**.

## WHAT MAKES A GOOD OUTDOOR FABRIC?

- A fabric that has **technical qualities enabling it to withstand sustained outdoor use without deteriorating** (colour-fastness to UV rays, water-repellent, resistant to stains and mould, etc.)
- A **fabric that's easy to keep clean** (removable cover, machine-washable, etc.).



Colour-fast  
in the sun



Water-repellent  
treatment



Breathable:  
quick-drying



Anti-stain  
treatment



Tearproof  
and resistant to  
abrasion



Removable  
covers



Machine  
washable

**Abrasion** : Wear caused by rubbing.

**Anti-UV** : Anti-UV treated products are resistant to alteration caused by ultraviolet rays (present in sunlight and moonlight), meaning colours do not fade over time. All Fermob products are UV-resistant.

**Water-repellent** : A water-repellent fabric does not instantly absorb water droplets. Instead, water slides off the surface. This increases the resistance to stains and mould. However, if the water is not removed quickly, it will end up being absorbed into the fibre (water-repellent is not the same as waterproof).

**Rotproof** : Guarantees against the formation of mould over time. This is an important guarantee for outdoor products.

For its decorative accessories and parasol, Fermob has chosen to work with **manufacturers who have genuine outdoor know-how** (like Serge Ferrari, Marguero and Tuva Textile) to ensure that its customers can enjoy a high-quality product, whatever they use it for. Like all Fermob products, they incorporate the fundamentals of the brand: **creativity, design, colour**, and combine an attractive appearance with **originality and technicality**.

## QUALITY GUARANTEED

Fermob's accessories are built to the same high standards as the brand's other products :

- Metal accessories (trays, trivets, etc.) are manufactured in the same factories as Fermob furniture, meaning they are designed with the exact same materials (metal, paint, etc.).
- Textile accessories (cushions, etc.) and parasol are designed in conjunction with experts (stylists, designers, manufacturers, etc.), all selected for adhering to the same exacting standards as Fermob. All our fabrics are sourced from partners in France or the European Union. Our **Jacquard fabrics, printed fabrics** and **Batylite® Outdoor Technical Fabric (OTF)** are all **made in France**.



All Fermob textile accessories are made with fabrics that meet relevant standards and undergo resistance tests.

- Colour-fastness (sunlight and inclement weather) standards : ISO 105-B04 & 105-B02
- Abrasion and friction resistance standard : ISO 12947-1 (Martindale's method)
- Tear resistance standard : ISO 13937

## OUR CARE AND MAINTENANCE RECOMMENDATIONS



To preserve their original appearance, most of our materials require **basic precautions**. They can be damaged, to a varying extent, depending on the product type, by:

- **mechanical** factors: wear and tear, scratches, impact, distortion, etc.
- **chemical** factors: acids, bases, solvents, etc.

**Cushions must be brought inside during bad weather.**

## MAINTENANCE OF OUTDOOR TECHNICAL FABRIC (OTF)



**Use soapy water or Fermob multi-purpose cleaner.**



Spray or apply with a **soft sponge**.  
Rub gently with a soft brush.  
**Rinse with water.**



**Wipe clean.**

N.B. Very dirty surfaces may require a second cleaning.

## MAINTENANCE OF ACRYLIC FABRIC (YARN-DYED / SOLUTION-DYED)



Gently brush the fabric if there are stains or other marks.



**Machine-wash on a gentle cycle** compatible materials, following the recommendations on the label.



**Iron the fabric** if necessary.

## MAINTENANCE OF COTTON FABRIC



**Machine-wash on a gentle cycle** compatible materials, following the recommendations on the label.



**Iron the fabric** if necessary.

N.B. Prefer 800 RPM spinning.

## MAINTENANCE OF METAL

See PROTECTION & MAINTENANCE chapter.

### SYMBOLS

#### RECOMMENDED USAGE



#### COLOURS



No. of available colours for the product

#### METAL ACCESSORIES CHARACTERISTICS



Stacking

#### FABRIC ACCESSORIES CHARACTERISTICS



Water repellent fabric



Machine washable at 30°C



Removable covers



Brush the fabric if there are stains or other marks



Iron-safe

## ACRYLIC

Synthetic fibre that is soft and silky to the touch, does not pill, and is ultra-light.

- extremely resistant to tearing and wear
- rotproof (i.e. prevents the formation of mould)
- keeps its shape
- does not retain heat or moisture
- resistant to temperature variations (-30° to +70°C)
- resistant to chemicals
- easy to clean: machine-washable at 30°C.

All our acrylic fabrics are water-repellent.

## DRALON®

A woven textile made from synthetic fibre that offers excellent resistance to water, stains and UV rays. It is soft in texture, bright in appearance, rot-proof and easy to clean.

## COATING

A treatment process in which a coating is applied to the surface of a textile to make it waterproof.

## FOAMS

### ETHYLENE-VINYL ACETATE (EVA) FOAM

A dense, compact, hard-wearing foam (no cells or air bubbles) that's lightweight and easy to mould.

### HIGH-RESILIENCE PU FOAM

A polyurethane foam selected by Fermob for its ability to return to its original shape after deformation, even following an extended period of use.

### OPEN-CELL FOAM

A foam that allows liquid to pass through. It does not retain water and dries very quickly, meaning that the cushion does not stay wet.

### POLYESTER FOAM

A PU-type foam with open cells and variable density. This versatile foam is typically used to make padding and occasional seats.

### POLYETHYLENE FOAM (closed-cell)

A foam used for thermal insulation and for air-, water- and dust-proofing.

### POLYURETHANE (PU) FOAM

A high-quality foam known for its firmness and comfort. It consists of fine closed cells enclosing a low thermal conductivity gas. It makes an excellent thermal insulator.

### RETICULATED FOAM

A foam with very fine, regular closed cells. This is a rot-proof and waterproof foam.

## YARN-DYED ACRYLIC

A yarn-dyed synthetic fibre is dyed on the yarn after it has been manufactured.

## SOLUTION-DYED

Fermob uses solution-dyed textiles (the dye is applied to the fibre, not the surface). This dyeing technique means that the colour lasts five times longer than a conventional dye.

## JACQUARD FABRIC

On a Jacquard fabric, the patterns are made by criss-crossing threads. The Jacquard loom, developed in 1801 by Joseph Marie Jacquard from Lyon, is capable of creating weaves with complex patterns.

## LOUNGE OTF

Outdoor Technical Fabric (OTF) is a Batyline® fabric manufactured in France by the world's leading firm, Serge Ferrari. This high-tenacity 100% polyester thread is protected with a solution-dyed PVC cover for exceptional colour-fastness. OTF keeps its shape, is light, flexible and sturdy, and does not deteriorate over time. It is resistant to both moisture and micro-organisms, and is treated with an anti-fungal product. The tight weave, coupled with the performance characteristics of Batyline®, give this material a textile-like feel and make it ideally suited for outdoor use. Lounge OTF is a unique material which combines the elegance of a natural-looking textile with the performance characteristics of a technical fabric.

# SHADOO

8010 - PARASOL Ø 250 CM

DESIGN STUDIO FERMOB



Solution-dyed acrylic outdoor fabric 260 Xg/m<sup>2</sup>  
 Parasol with a finished hem  
 White aluminium tubular mast Ø 40 mm - Thickness : 2mm  
 Collapsible pole (2 clip-together sections)  
 8 ribs fiber glass Ø 8 mm  
 Opening : Clip-on slide opening  
 Bag for storage  
Compatible base:  
 CONCRETE BASE - BASICS  
Compatible with :  
 TABLE Ø 117 CM - OPÉRA+  
 TABLE 143 X 80 CM - LUXEMBOURG  
 FOUR-LEG TABLE 80 x 80 CM - LUXEMBOURG



4.65 kg

8010A5 Clay Grey  
 8010A7 Ice Mint

8010A6 Frosted Lemon  
 801082 Cactus **NEW**

## BASICS

8090 - CONCRETE BASE



Concrete base  
 White sheath  
 Compatible with mast from Ø25 to 55 mm  
Compatible with :  
 PARASOL Ø 250 CM - SHADOO

809000 White



30 kg

SHADOO



PARASOLS  
& ACCESSORIES

# ACCROCHE CŒURS

9690 - COAT STAND  
 DESIGN BY PASCAL MOURGUE

DOMESTIC | PROFESSIONAL | INTENSIVE



Tubular aluminium frame  
 Cast iron base (13 kg) - Liquorice  
 8 steel wire hooks

- |        |  |               |        |  |                        |
|--------|--|---------------|--------|--|------------------------|
| 969021 |  | Acapulco Blue | 9690C6 |  | Honey                  |
| 969082 |  | Cactus        | 969047 |  | Anthracite             |
| 9690A5 |  | Clay Grey     | 9690A6 |  | Frosted Lemon          |
| 9690B9 |  | Red Ochre     | 969083 |  | Opaline Green          |
| 969020 |  | Black Cherry  | 9690D2 |  | Gingerbread <b>NEW</b> |
| 969045 |  | Capucine      |        |  |                        |



ACCROCHE-COEURS





# ACROBATE

9693 - PEG

DOMESTIC | PROFESSIONAL | INTENSIVE



Steel frame  
2 steel wire hooks

- |        |  |               |        |  |                        |
|--------|--|---------------|--------|--|------------------------|
| 969321 |  | Acapulco Blue | 9693C6 |  | Honey                  |
| 969382 |  | Cactus        | 969347 |  | Anthracite             |
| 9693A5 |  | Clay Grey     | 9693A6 |  | Frosted Lemon          |
| 9693B9 |  | Black Cherry  | 969383 |  | Opaline Green          |
| 969320 |  | Red Ochre     | 9693D2 |  | Gingerbread <b>NEW</b> |
| 969345 |  | Capucine      |        |  |                        |

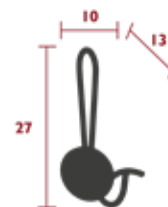

0.8 kg



ACROBATE



# ALTO

3170 - TRAY 53 X 38.5 CM  
DESIGN BY STUDIO FERMOB

DOMESTIC PROFESSIONAL INTENSIVE



Steel sheet  
Steel wire handles



- 317021 ● Acapulco Blue
- 317082 ● Cactus
- 3170A5 ● Clay Grey
- 3170B9 ● Black Cherry
- 317020 ● Red Ochre
- 317045 ● Capucine

**NEW**  
**NEW**  
**NEW**

- 3170C6 ● Honey
- 317047 ● Anthracite
- 3170A6 ● Frosted Lemon
- 317083 ● Opaline Green
- 3170D2 ● Gingerbread

**NEW**  
**NEW**  
**NEW**  
**NEW**

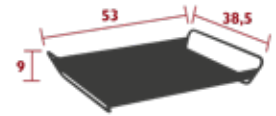

2 kg

3171 - TRAY 36 X 23.5 CM  
DESIGN BY STUDIO FERMOB

DOMESTIC PROFESSIONAL INTENSIVE



Steel sheet



- 317121 ● Acapulco Blue
- 317182 ● Cactus
- 3171A5 ● Clay Grey
- 3171B9 ● Black Cherry
- 317120 ● Red Ochre
- 317145 ● Capucine

**NEW**  
**NEW**  
**NEW**  
**NEW**

- 3171C6 ● Honey
- 317147 ● Anthracite
- 3171A6 ● Frosted Lemon
- 317183 ● Opaline Green
- 3171D2 ● Gingerbread

**NEW**  
**NEW**  
**NEW**  
**NEW**

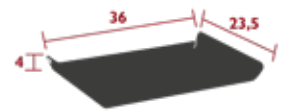

0.6 kg

3172 - TRAY 23 X 17 CM  
DESIGN BY STUDIO FERMOB

**NEW**

DOMESTIC PROFESSIONAL INTENSIVE



Steel sheet



- 317221 ● Acapulco Blue
- 317282 ● Cactus
- 3172A5 ● Clay Grey
- 3172B9 ● Black Cherry
- 317220 ● Red Ochre
- 317245 ● Capucine

- 3172C6 ● Honey
- 317247 ● Anthracite
- 3172A6 ● Frosted Lemon
- 317283 ● Opaline Green
- 3172D2 ● Gingerbread

**NEW**  
**NEW**  
**NEW**  
**NEW**

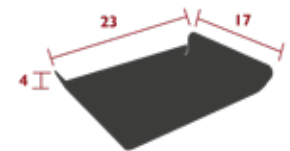

0.32 kg



# BASICS

## 2780 - OUTDOOR CUSHION Ø 39 CM



OTF Batyline® Lounge fabric - high-tenacity 100% polyester thread coated in solution-dyed PVC  
 Polyurethane open-cell foam, guaranteed rotproof  
 Tightly woven, textile look and feel  
 Magnets ties  
Compatible with :  
 CHAIR - I 900, LOUVRE, MONTMARTRE & OPÉRA+  
 ARMCHAIR - AIRLOOP & OPÉRA+  
 LOW CONSOLE TABLE - BEBOP



278077 Almond Green    278075 Midnight Grey  
 2780A8 Beige

## 2781 - OUTDOOR CUSHION Ø 43 CM



OTF Batyline® Lounge fabric - high-tenacity 100% polyester thread coated in solution-dyed PVC  
 Polyurethane open-cell foam, guaranteed rotproof  
 Tightly woven, textile look and feel  
 Magnets ties  
Compatible with :  
 ARMCHAIR - I 900, LOUVRE & MONTMARTRE



278177 Almond Green    278175 Midnight Grey  
 2781A8 Beige

## 2750 - OUTDOOR CUSHION 37 X 41 CM



OTF Batyline® Lounge fabric - high-tenacity 100% polyester thread coated in solution-dyed PVC  
 Polyurethane open-cell foam, guaranteed rotproof  
 Tightly woven, textile look and feel  
Compatible with :  
 CHAIR & ARMCHAIR - LUXEMBOURG STEEL  
 CHAIR, ARMCHAIR & BAR CHAIR - LUXEMBOURG



275077 Almond Green    275075 Midnight Grey  
 2750A8 Beige

## 2751 - OUTDOOR CUSHION 96 X 47 CM



OTF Batyline® Lounge fabric - high-tenacity 100% polyester thread coated in solution-dyed PVC  
 Polyurethane open-cell foam, guaranteed rotproof  
 Tightly woven, textile look and feel  
 Elastic ties : fastening system for easy folding  
Compatible with :  
 LOW ARMCHAIR, LOUNGE ARMCHAIR & LOUNGE CHAIR - LUXEMBOURG  
 LOW ARMCHAIR - LUXEMBOURG STEEL

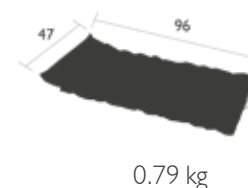

275177 Almond Green    275175 Midnight Grey  
 2751A8 Beige    275101 Cotton White

# BASICS

## 2777 - OUTDOOR CUSHION 171 X 44 CM



OTF Batyline® Lounge fabric - high-tenacity 100% polyester thread coated in solution-dyed PVC  
 Polyurethane open-cell foam, guaranteed rotproof  
 Tightly woven, textile look and feel  
 Elastic ties : fastening system for easy folding

Compatible with :  
 CHAISE LONGUE - BISTRO



1.39 kg

- 277777 Almond Green      277775 Midnight Grey  
 2777A8 Beige

## 2778 - SKIN OUTDOOR CUSHION 45 X 40 CM



Solution-dyed acrylic Sunbrella® fabric  
 EVA foam  
 Thermo-compressed cushion  
 Velcro ties  
 Compatible with :  
 CHAIR & ARMCHAIR - LUXEMBOURG STEEL  
 CHAIR, ARMCHAIR & BAR CHAIR - LUXEMBOURG

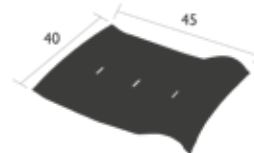

0.28 kg

- 277854 Grey

## 2776 - BISTRO OUTDOOR CUSHION 38 X 28 CM



OTF Batyline® Duo or Stereo fabric - high-tenacity 100% polyester thread coated in solution-dyed PVC  
 Polyethylene foam  
 Elastic ties  
 Compatible with :  
 METAL CHAIR, VALET CHAIR & FOLDABLE BAR CHAIR - BISTRO

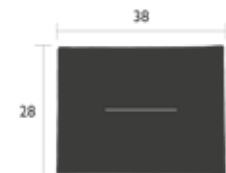

0.17 kg

- 277673 Honey      277620ST Stereo Red ochre  
 277643 Chili      277648ST Stereo Rosemary  
 277682 Cactus      277626ST Stereo Storm Grey  
 277647ST Stereo Anthracite      277621ST Stereo Acapulco Blue **NEW**  
 2776A5ST Stéréo Gris argile **NEW**

## 2600 - PLACEMAT 45 X 35 CM



OTF Batyline® Duo or Stereo fabric - high-tenacity 100% polyester thread coated in solution-dyed PVC  
 Easy to clean with soap and water

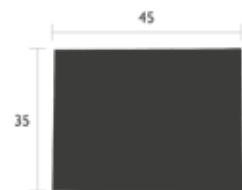

0.13 kg

- 260073 Honey      2600A5ST Stereo Clay grey  
 260001 Cotton White      260020ST Stereo Red ochre  
 260043 Chili      260048ST Stereo Rosemary  
 260082 Cactus      260026ST Stereo Storm Grey **NEW**  
 260047ST Stereo Anthracite      260021ST Stereo Acapulco Blue **NEW**

BOUQUET SAUVAGE, BEBOP & MOOON!



BOUQUET SAUVAGE & PIAPOLO



BOUQUET SAUVAGE



# BOUQUET SAUVAGE

2682 - TULIPE OUTDOOR CUSHION 44 X 44 CM



Cotton outdoor fabric  
Resistant to stains and mould  
Polyester foam

2682D2 ● Gingerbread **NEW** 2682D1 ● Marshmallow **NEW**



0.43 kg

2684 - PIXELS OUTDOOR CUSHION 44 X 44 CM



Cotton outdoor fabric  
Resistant to stains and mould  
Polyester foam

2684D2 ● Gingerbread **NEW** 2684D1 ● Marshmallow **NEW**

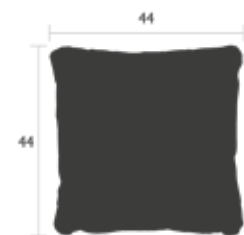

0.50 kg

2680 - CHAMPÊTRE OUTDOOR CUSHION 68 X 44 CM



Cotton outdoor fabric  
Resistant to stains and mould  
Polyester foam

2680A5 ● Clay grey **NEW** 2680A7 ● Ice Mint **NEW**



0.89 kg

# BOUQUET SAUVAGE

3008 - CACTUS TRIVET 25.5 X 24 CM



Steel  
Non slip pads

300882 ● Cactus **NEW**  
300820 ● Red Ochre

3008A7 ● Ice Mint  
3008A5 ● Clay Grey

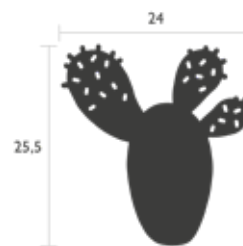

0.46 kg

3018 - MONSTERA TRIVET 24 X 22 CM



Steel  
Non slip pads

301848 ● Rosemary **NEW**  
301821 ● Acapulco Blue

301883 ● Opaline Green  
3018B9 ● Black Cherry

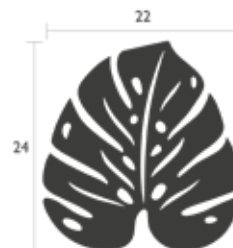

0.46 kg



BOUQUET SAUVAGE

# COLOR MIX

2722 - OUTDOOR CUSHION Ø 40 CM



Dralon® solution-dyed acrylic  
 Polyurethane foam  
 Density 30 kg/m<sup>3</sup>  
 Coloured PVC strap fastened with a snap button (do not iron)  
Compatible with :  
 CHAIR - I 900, LOUVRE, MONTMARTRE & OPÉRA+  
 ARMCHAIR - AIRLOOP, MONTMARTRE & OPÉRA+

- |          |                |        |                    |
|----------|----------------|--------|--------------------|
| 2722A4   | ● Burgundy     | 2722B1 | ● Mint             |
| 272297   | ● Twine        | 2722C3 | ● Apricot          |
| 272286A5 | ● Safari Green | 2722C2 | ● Eucalyptus Green |
| 272296   | ● Night Blue   |        |                    |

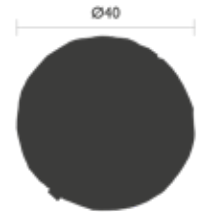

0.17 kg

2720 - BISTRO OUTDOOR CUSHION 38 X 30 CM



Dralon® solution-dyed acrylic  
 Polyurethane foam  
 Density 30 kg/m<sup>3</sup>  
 Coloured PVC strap fastened with a snap button (do not iron)  
Compatible with :  
 METAL CHAIR, VALET CHAIR & FOLDABLE BAR CHAIR - BISTRO

- |          |                |        |                    |
|----------|----------------|--------|--------------------|
| 2720A4   | ● Burgundy     | 2720B1 | ● Mint             |
| 272097   | ● Twine        | 2720C3 | ● Apricot          |
| 272086A5 | ● Safari Green | 2720C2 | ● Eucalyptus Green |
| 272096   | ● Night Blue   |        |                    |

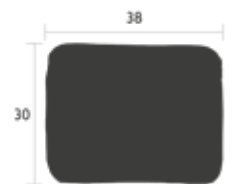

0.15 kg

2721 - OUTDOOR CUSHION 41 X 38 CM



Dralon® solution-dyed acrylic  
 Polyurethane foam  
 Density 30 kg/m<sup>3</sup>  
 Coloured PVC strap fastened with a snap button (do not iron)  
Compatible with :  
 CHAIR, ARMCHAIR STOOL, BAR STOOL & BAR CHAIR - LUXEMBOURG  
 CHAIR & ARMCHAIR - LUXEMBOURG STEEL  
 ARMCHAIR, XL ARMCHAIR & STOOL - MONCEAU

- |          |                |        |                    |
|----------|----------------|--------|--------------------|
| 2721A4   | ● Burgundy     | 2721B1 | ● Mint             |
| 272197   | ● Twine        | 2721C3 | ● Apricot          |
| 272186A5 | ● Safari Green | 2721C2 | ● Eucalyptus Green |
| 272196   | ● Night Blue   |        |                    |



0.2 kg





COLOR MIX



COLOR MIX

# COLOR MIX

2728 - BENCH OUTDOOR CUSHION 106 X 35 CM



Dralon® solution-dyed acrylic  
 Polyurethane foam  
 Density 30 kg/m<sup>3</sup>  
 Coloured PVC strap fastened with a snap button (do not iron)  
Compatible with :  
 2/3-SEATER BENCH WITH BACKREST & GARDEN BENCH- LUXEMBOURG  
 2/3-SEATER BENCH - MONCEAU

- |        |                |        |                    |
|--------|----------------|--------|--------------------|
| 2728A4 | ● Burgundy     | 2728B1 | ● Mint             |
| 272897 | ● Twine        | 2728C3 | ● Apricot          |
| 272886 | ● Safari Green | 2728C2 | ● Eucalyptus Green |
| 272896 | ● Night Blue   |        |                    |



0,54 kg

2727 - SET OF 2 OUTDOOR CUSHION 41 X 45 CM



Dralon® solution-dyed acrylic  
 Polyurethane foam  
 Density 30 kg/m<sup>3</sup>  
 Coloured PVC strap fastened with a snap button (do not iron)  
Compatible with :  
 LOW ARMCHAIR & ROCKING CHAIR - MONCEAU  
 LOW ARMCHAIR, LOUNGE ARMCHAIR & LOUNGE CHAIR - LUXEMBOURG

- |          |                |        |                    |
|----------|----------------|--------|--------------------|
| 2727A4   | ● Burgundy     | 2727B1 | ● Mint             |
| 272797   | ● Twine        | 2727C3 | ● Apricot          |
| 272786A5 | ● Safari Green | 2727C2 | ● Eucalyptus Green |
| 272796   | ● Night Blue   |        |                    |

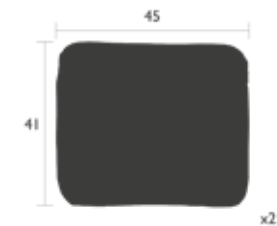

0.64 kg

3141 - HEADREST 44 X 15 X 5.5 CM



Dralon® solution-dyed acrylic  
 Polyurethane foam  
 Density 30 kg/m<sup>3</sup>  
 Coloured PVC strap fastened with a snap button (do not iron)  
Compatible with :  
 SUNLOUNGER & XS SUNLOUNGER - ALIZÉ  
 SUNLOUNGER - DUNE  
 CHAISE LONGUE - BISTRO

- |          |                |        |                    |
|----------|----------------|--------|--------------------|
| 3141A4   | ● Burgundy     | 3141B1 | ● Mint             |
| 314197   | ● Twine        | 3141C3 | ● Apricot          |
| 314186A5 | ● Safari Green | 3141C2 | ● Eucalyptus Green |
| 314196   | ● Night Blue   |        |                    |

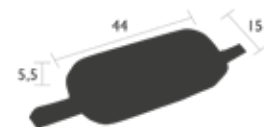

0.230 kg



DUO DE GALETTES

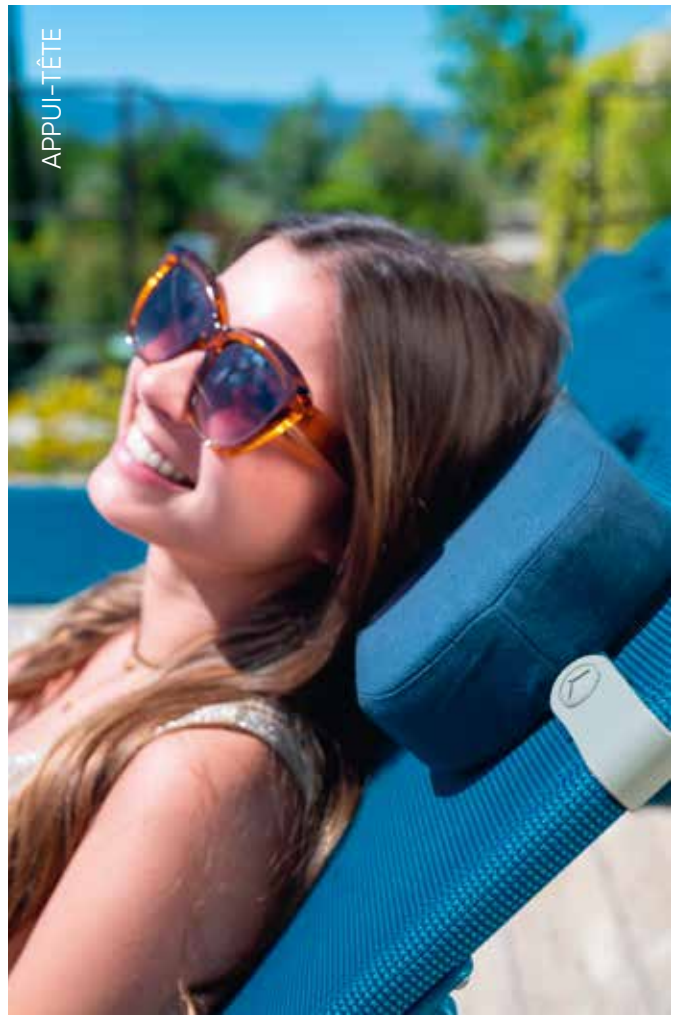

APPUJ-TÊTE



COLOR MIX, BOUQUET SAUVAGE, MONCEAU

# COLOR MIX

2724 - OUTDOOR CUSHION 44 X 30 CM



Dralon® solution-dyed acrylic  
Polyester foam  
Coloured PVC strap fastened with a snap button (do not iron)

- |        |                |        |                    |
|--------|----------------|--------|--------------------|
| 2724A4 | ● Burgundy     | 2724B1 | ● Mint             |
| 272497 | ● Twine        | 2724C3 | ● Apricot          |
| 272486 | ● Safari Green | 2724C2 | ● Eucalyptus Green |
| 272496 | ● Night Blue   |        |                    |



0.4 kg

2729 - OUTDOOR CUSHION Ø 50 CM



Dralon® solution-dyed acrylic  
Polyester foam  
Coloured PVC strap fastened with a snap button (do not iron)

- |        |                |        |                    |
|--------|----------------|--------|--------------------|
| 2729A4 | ● Burgundy     | 2729B1 | ● Mint             |
| 272997 | ● Twine        | 2729C3 | ● Apricot          |
| 272986 | ● Safari Green | 2729C2 | ● Eucalyptus Green |
| 272996 | ● Night Blue   |        |                    |



0,55 kg



COLOR MIX

# COLOR MIX

3102 - FOUTA TOWEL 200 X 100 CM



Cotton fabric  
 Back : plain terry cotton  
 Fringe finish  
 Coloured PVC strap fastened with a snap button (do not iron)

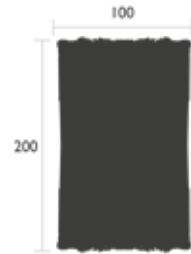

- |        |  |                   |        |  |             |
|--------|--|-------------------|--------|--|-------------|
| 3102A2 |  | Chlorophyll Green | 310284 |  | Jade Green  |
| 310273 |  | Honey             | 3102C4 |  | Coral       |
| 310295 |  | Powder Pink       | 3102C5 |  | Olive Green |
| 3102B2 |  | Pebble Grey       |        |  |             |

0.69 kg



COLOR MIX



# ÉVASION

2692 - OUTDOOR CUSHION 44 X 30 CM



Dralon® solution-dyed acrylic  
Jacquard fabric  
Teflon® treated : resistant to stains and mould  
Polyester foam



2692A1 ● Atacama  
2692A9 ● Panama

2692B5 ● Etna



0.38 kg

2693 - OUTDOOR CUSHION 44 X 44 CM



Dralon® solution-dyed acrylic  
Jacquard fabric  
Teflon® treated : resistant to stains and mould  
Polyester foam



2693A1 ● Atacama  
2693A9 ● Panama

2693B5 ● Etna



0.53 kg

2694 - OUTDOOR CUSHION 35 X 70 CM



Dralon® solution-dyed acrylic  
Jacquard fabric  
Teflon® treated : resistant to stains and mould  
Polyester foam



2694A1 ● Atacama  
2694A9 ● Panama

2694B5 ● Etna



0.65 kg

2695 - OUTDOOR CUSHION 68 X 44 CM



Dralon® solution-dyed acrylic  
Jacquard fabric  
Teflon® treated : resistant to stains and mould  
Polyester foam



2695A1 ● Atacama  
2695A9 ● Panama

2695B5 ● Etna



0.78 kg

EVASION, COLOR MIX, BOUQUET SAUVAGE



PARASOLS  
& ACCESSORIES

3129 - SINGLE-STEM VASE  
 DESIGN BY STUDIO FERMOB



Steel sheet frame  
 Removable and waterproof aluminium tube tank

- |        |                 |        |                          |
|--------|-----------------|--------|--------------------------|
| 312920 | ● Red Ochre     | 3129C6 | ● Honey                  |
| 312947 | ● Anthracite    | 312982 | ● Cactus                 |
| 312921 | ● Acapulco Blue | 3129A6 | ● Frosted Lemon          |
| 3129A5 | ● Clay Grey     | 312983 | ● Opaline Green          |
| 3129B9 | ● Black Cherry  | 3129D2 | ● Gingerbread <b>NEW</b> |
| 312945 | ● Capucine      |        |                          |

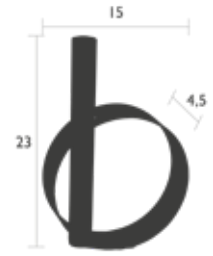

0.42 kg



IOS





# ITAC

## 3120 - RECTANGULAR VASE H. 62 CM DESIGN BY STUDIO FERMOB



Steel wire  
Tubular steel  
Leakproof, removable reservoir

- |        |   |               |        |   |                        |
|--------|---|---------------|--------|---|------------------------|
| 312020 | ● | Red Ochre     | 3120C6 | ● | Honey                  |
| 312047 | ● | Anthracite    | 312082 | ● | Cactus                 |
| 312021 | ● | Acapulco Blue | 3120A6 | ● | Frosted Lemon          |
| 3120A5 | ● | Clay Grey     | 312083 | ● | Opaline Green          |
| 3120B9 | ● | Black Cherry  | 3120D2 | ● | Gingerbread <b>NEW</b> |
| 312045 | ● | Capucine      |        |   |                        |

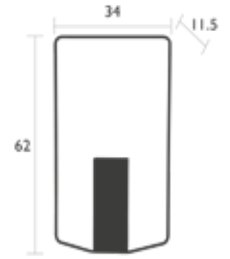

1.9 kg

## 3121 - CYLINDRICAL VASE H. 76 CM DESIGN BY STUDIO FERMOB



Steel wire  
Tubular steel  
Leakproof, removable reservoir

- |        |   |               |        |   |                        |
|--------|---|---------------|--------|---|------------------------|
| 312120 | ● | Red Ochre     | 3121C6 | ● | Honey                  |
| 312147 | ● | Anthracite    | 312182 | ● | Cactus                 |
| 312121 | ● | Acapulco Blue | 3121A6 | ● | Frosted Lemon          |
| 3121A5 | ● | Clay Grey     | 312183 | ● | Opaline Green          |
| 3121B9 | ● | Black Cherry  | 3121D2 | ● | Gingerbread <b>NEW</b> |
| 312145 | ● | Capucine      |        |   |                        |

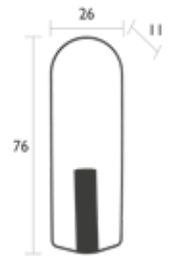

2.05 kg



# LORETTE

2712 - OUTDOOR CUSHION 44 X 44 CM



Dralon® solution-dyed acrylic  
Jacquard fabric  
Teflon® treated : resistant to stains and mould  
Polyester foam

271242 ● Liquorice  
271210 ● Sage Green

2712C1 ● Blush Pink



0.53 kg

2713 - OUTDOOR CUSHION 68 X 44 CM



Dralon® solution-dyed acrylic  
Jacquard fabric  
Teflon® treated : resistant to stains and mould  
Polyester foam

271342 ● Liquorice  
271310 ● Sage Green

2713C1 ● Blush Pink



0.78 kg

3010 - TRIVET 22 X 17.5 CM

DESIGN BY FRÉDÉRIC SOFIA

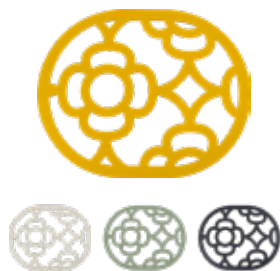

Steel  
Non slip pads

301082 ● Cactus  
301047 ● Anthracite

3010C6 ● Honey **NEW**  
3010A5 ● Clay Grey

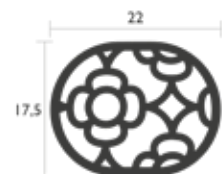

0.3 kg

# PICOTI

3089 - BIRD FEEDER  
 DESIGN BY CATHERINE SOFIA

NEW

DOMESTIC | PROFESSIONAL | INTENSIVE



Steel sheet frame  
 Removable stainless steel bowl  
 100% polyester outdoor cord  
 Double fastening system: suspension or screws (not provided)

- |        |                 |        |                          |
|--------|-----------------|--------|--------------------------|
| 3089B9 | ● Black Cherry  | 308947 | ● Anthracite             |
| 308920 | ● Red Ochre     | 3089A5 | ● Clay Grey              |
| 308945 | ● Capucine      | 3089A6 | ● Frosted Lemon          |
| 3089C6 | ● Honey         | 308983 | ● Opaline Green          |
| 308982 | ● Cactus        | 3089D2 | ● Gingerbread <b>NEW</b> |
| 308921 | ● Acapulco Blue |        |                          |

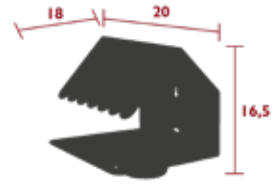

0.8 kg



# TRÈFLE

## 2742 - OUTDOOR CUSHION 44 X 30 CM



Dralon® solution-dyed acrylic  
Jacquard fabric  
Teflon® treated : resistant to stains and mould  
Polyester foam



- |        |           |        |           |
|--------|-----------|--------|-----------|
| 274282 | Cactus    | 274285 | Duck Blue |
| 274220 | Red Ochre | 2742A5 | Clay Grey |

0.38 kg

## 2741 - OUTDOOR CUSHION 44 X 44 CM



Tissu outdoor acrylique teint fil Dralon®  
Tissu Jacquard  
Traitement Téflon® : résistant aux taches et à la moisissure  
Mousse polyester

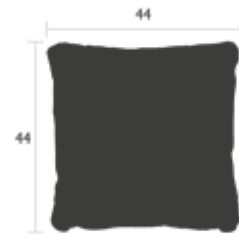

- |        |           |        |               |
|--------|-----------|--------|---------------|
| 274182 | Cactus    | 274192 | Duck Blue     |
| 274120 | Red Ochre | 274173 | Honey         |
| 274185 | Duck Blue | 2741A6 | Frosted Lemon |

0.53 kg

## 2740 - OUTDOOR CUSHION 68 X 44 CM



Dralon® solution-dyed acrylic  
Jacquard fabric  
Teflon® treated : resistant to stains and mould  
Polyester foam



- |        |           |        |           |
|--------|-----------|--------|-----------|
| 2740A7 | Ice Mint  | 274092 | Duck Blue |
| 274020 | Red Ochre | 274073 | Honey     |
| 274085 | Duck Blue | 2740A5 | Clay Grey |

0.78 kg

## 3004 - TRIVET 27 X 27 CM



Steel  
Non slip pads

- |        |               |        |                         |
|--------|---------------|--------|-------------------------|
| 300482 | Cactus        | 3004B9 | Black Cherry <b>NEW</b> |
| 3004A6 | Frosted Lemon | 3004C7 | Lapilli Grey <b>NEW</b> |



0.79 kg









# THE LIGHTING COLLECTIONS

IN JUST A FEW YEARS, FERMOB HAS BECOME A LEADING NAME IN DECORATIVE AND AUTONOMOUS LIGHTING FOR BOTH INDOOR & OUTDOOR SPACES.

It all began in 2015, when Fermob released the market's very first portable BALAD lamp. Thanks to this product, Fermob became a pioneer with a new concept.



						
<i>Balad</i> (2015)	<i>Moon!</i> (2017)	<i>Inoui</i> (2020)	<i>Hoopik</i> (2020)	<i>Aplô</i> (2021)	<i>Ludo</i> (2022)	<i>Oto</i> (2023)

## INNOVATION FIRST...

### CREATION

Apart from quality, **design is a major commitment for Fermob**. With an approach **inspired by changing lifestyles** and history, the products also combine Fermob's **commitments to simplicity, a feeling for detail and, of course, aesthetics**. As well as forming part of our **overall design vision**, the collections are also in step with our observations of **new uses**. Fermob offers a variety of products (table lamps, pendant lights, wall lights, etc.) for a range of lighting scenarios (with different light temperatures, intensities, etc.).

### DESIGN

Our development protocol takes everything into account: ergonomics, weight, ease of handling and sturdiness. The result is a product that is built to last & brings genuine delight. Fermob approaches new product developments with a manufacturer's eye, putting together its own know-how and connecting with the best partners for growth.

To support its growth in the lighting market, Fermob set up a **dedicated working group to combine different areas of expertise**. The brand also partnered up with **Smart & Green**, a start-up in Grenoble **specialising in development of portable and smart LED lights** (using Bluetooth 4.0 Smartmesh® technology).



### PRODUCTION

Production is entrusted to the **IPW industrial group** created by a joint French and Chinese team, and working closely with Fermob teams. **Specialising in plastic injection and electronics**, IPW develops LED lighting control software and systems.



**Innovative products that are affordable and accessible in terms of price point and ease of use, with strong environmental credentials (eco-designed, able to be taken apart, and energy efficient, due to use of LEDs)**



## FERMOB: A UNIQUE LIGHTING IDENTITY

Fermob lighting builds on the **fundamentals of the brand: ease of use, versatility, continuous innovation, a design approach.** Fermob, in tune with contemporary living, offers a **variety of products for a range of lighting scenarios** (with different light temperatures, intensities, etc.) & different accessories for **a unique user experience, just right for every different moment of life.**

**Whether wired or wireless,** all Fermob lighting products have something in common - **their simplicity and versatility in use.** Designed for **your table or floor, or to be portable or wall-mounted** Fermob lights offer **complementarity in use:** creating ambience at the table, lighting a bar space, highlighting a poolside area, marking out a path, etc.

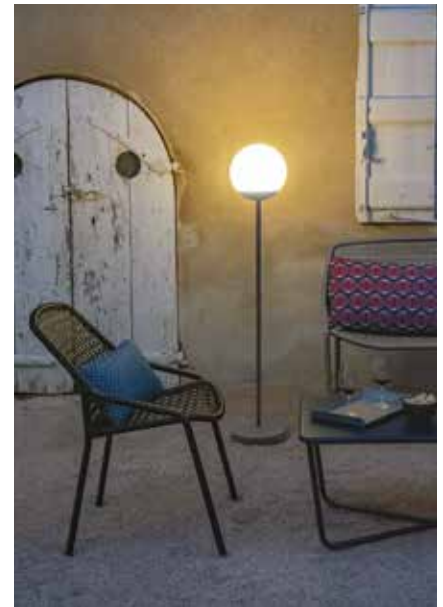

**A perfect combo for unique user experiences, just right for every different moment of life.**



# MAKE A LASTING IMPRESSION,

BUT NOT ON THE ENVIRONMENT!

As part of a **continuous improvement** approach, combined with genuine **“lighting quality” expertise**, the brand designs lighting that combines **eco-design with environmentally-friendly materials and processes** to use exactly the right amount of energy. We also pay careful attention to the **life span of our products** and are improving this factor for all of our products.



## ECO-DESIGN & DURABILITY

Fermob quality expertise is integrated into our projects from the initial conceptual phase through to design and production. Following marketing, our continuous improvement process allows us to extend the life span of our products.

## CONTINUOUS IMPROVEMENT TO REDUCE OUR ENVIRONMENTAL IMPACT

**Controlling our industrial processes** to reduce their impact on the environment is a major concern for Fermob, as it has been demonstrated regularly in the form of **practical actions**:

- **Lowering the temperature** used for our heating processes (-10°C in 25 years),
- Investment in a **new painting line**, which will be able to save 8 tonnes of powder per year,
- **Reduction in our water consumption** (-43% in 7 years),
- **Reduction in our electricity consumption** with integration of **LED lighting** into our factory (-5% in 5 years).



All our lighting is certified in a 2-stage procedure:

- The product design work includes performance of several tests in accordance with IEC 60598, testing component strength and uses (e.g. NF EN 60529, etc.)
- When Fermob receives the pre-production item, it performs tests on the complete product with SGS.

**SGS**



**IEC 60598:** The international standard, for all lighting that incorporates electric light sources, which specifies general requirements for operation at power supply voltages up to 1000 V. The requirements and the corresponding tests for this standard are concerned with classification, marking and mechanical and electrical construction.

**SGS** SGS: World leader in inspection, testing, analysis and certification.

## SELECTION OF ECO-RESPONSIBLE MATERIALS AND COMPONENTS



### LED

Recyclable and far more environmentally-friendly than all other types of lighting. They offer a long life span, with 85% lower energy consumption and no toxic mercury content.



### DURABLE AND RECYCLABLE HIGH-PERFORMANCE ELECTRONIC AND ELECTRICAL COMPONENTS

E.g. battery and LED PCB module  
(PCB: Printed Circuit Board)



### ENVIRONMENTALLY-FRIENDLY PAINTS

Better for the environment and for our health. The powder coatings used by Fermob are solvent-free. They are used in a zero waste system and are guaranteed for outdoor use.



### METAL

An eco-responsible material. Iron and aluminium are 98% recyclable materials, and have the benefit of a mature value chain at international level.



### POLYETHYLENE OR POLYCARBONATE DIFFUSER

Very strong materials, with the benefit of being recyclable even after being recycled.



### GLASS DIFFUSER

A material that has the benefit of being 85% recyclable.

## DISASSEMBLING LIGHTING TO IMPROVE LIFE SPAN

Fermob considers the design of its lighting products to make them easier to disassemble and to extend their life span. Several components can be replaced (see detailed list on p.44 and in Price list).

Each package is marked with repairability symbols indicating the type of disassembly (requiring a professional or able to be completed by user) and specifying the type of repairability (light source and/or control unit).

Detailed key to repairability symbols:



Light source can be replaced by a professional

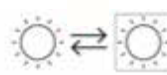

Light source can be replaced by user



Light source (LED only) can be replaced by a professional

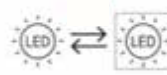

Light source (LED only) can be replaced by user



Control device can be replaced by a professional



Control device can be replaced by user



Light source cannot be replaced



Control device cannot be replaced



Since 1st September 2021, in accordance with the requirements of the AGEC law:

- the new labelling of all household appliances, light sources and lighting products (Light output  $\geq 60$  lm)
- the new method for analysing energy consumption.

Repairability symbols



QR code giving access to the European database for energy labelling - EPREL.

It fills in the technical information & details (materials, dimensions, energy class, etc.).

## WHERE CAN I DISPOSE OF A USED LIGHT?

When disposing of a **used lighting product**, it is mandatory to **disassemble your light and place it at an authorised collection site**. The instructions and packaging give the user information, by means of regulated markings, to ensure that the materials can be recycled or recovered at the end of their life.



Manufacturers and users have **obligations in terms of management of Waste Electrical and Electronic Equipment (WEEE)**. This symbol indicates that the lighting products must not be put in bins intended for household waste.



### AT WASTE CENTRES

These sites, generally managed by local authorities, take your used products and transfer them to the appropriate processing systems.



### AT SHOPS

Stores that sell these lighting products are obliged to take back the used products, whether they are small independent traders or large specialist shops.

Fermob

### AT THE MANUFACTURER'S PREMISES

Manufacturers take back the used products and transfer them to the appropriate processing systems.



Fermob is **affiliated with ECOSYSTEM** for **processing of waste electrical and electronic equipment** and with **Screlec** for **recycling of batteries**, the latter since the start of the Lighting product collections.

ecosystem  
recycler c'est protéger

screlec  
ensemble vers une économie circulaire

## GLOSSARY

### ABS

Acrylonitrile Butadiene Styrene (ABS) is a relatively rigid, lightweight, impact-resistant and mouldable thermoplastic polymer (a type of styrenic polymer, to be exact).

### BYPASS

A bypass is a circuit that avoids a device or system.

### BATTERY USE CYCLES

The battery's capacity gradually decreases with the use of the light. This is a natural phenomenon. A use cycle includes a complete discharge and recharge of the battery (if the battery is discharged to 50% and then recharged to 100%, this is equivalent to 1/2 cycles). On average, Fermob lights vary between 300 and 500 cycles of use per battery.

### LUMINOUS FLUX - LUMEN (Lm)

In photometry, luminous flux is a measure of the power of a light source as perceived by the human eye. It's the most commonly used indicator of the total amount of light emitted by a light source in all directions.

### IK INDEX

Defines the strength of a device against knocks and impacts, but not against falls. The test is carried out with a steel vertical or pendulum hammer. The rating ranges from 0 to 10 (according to standard NF 62262).

### IP INDEX

Defines the degree of protection provided by the equipment against the penetration of solid matter (first figure) and liquid matter (second figure). The rating ranges from 00 to 68 (according to standard NF EN 60529).

### POLYETHYLENE

Polyethylene is one of the most common thermoplastic resins in use today. It is known for its excellent impact resistance.

### COLOUR TEMPERATURE - KELVIN (°K)

Measures the colour temperature of the light. It indicates whether white light is warm (yellow hue) or cool (blue hue). It varies depending on the source. The higher this figure, the more bluish-white the colour temperature, while light with a lower colour temperature tends towards the red end of the scale.

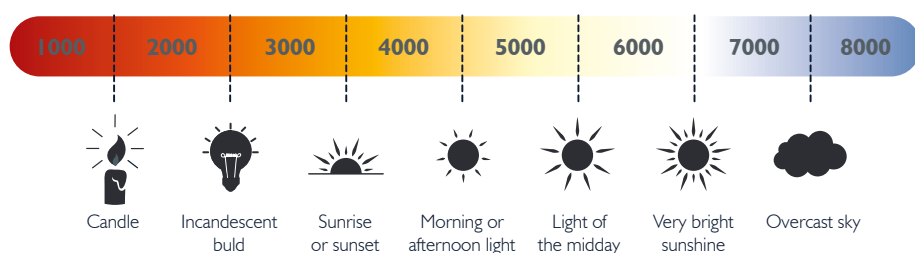

#### ALTER THE COLOUR TEMPERATURE TO CREATE THE RIGHT LIGHTING MOOD.

This feature lets you adjust the colour temperature to the task at hand. Warm white (2,700 to 3,300°K) creates a comfortable mood that's perfect for relaxing. Neutral white (4,200 to 4,500°K) is more soothing and energising. Cool white (5,500 to 6,500°K) is closest to natural daylight, with a slightly blue hue that boosts focus and concentration.

# THE PRODUCT DESCRIPTION STEP BY STEP

## Pictos at a glance

### Naming

Product + designer

3612 - LAMP H.25 CM  
DESIGN BY TRISTAN LOHNER



### Packshots

Product + packaging



- 1 Polyethylene diffuser  
Aluminium frame  
ABS base  
**Technology** : integrated LED - Luminous flux : 40 lm
- 2 **Switch type** : push button  
**Switch function** : change the light temperature & brightness (short click 1 s), OFF (long click 3 s)  
**Lighting mood** :  
Position 1 warm white (6000°K) 100%  
Position 2 neutral white (4000°K) 100%  
Position 3 neutral white (4000°K) 50%
- 3 Position 4 candle-style warm white (2300°K) flickering  
**Power supply type** : battery - Battery life : Min. 7 h - Max. 14 h
- 4 **Battery use cycles** : 300 cycles  
**Rechargeable** : 5 h - **Charging system** : USB, cable (supplied) 2m  
Bypass to prevent battery damage during wired use
- 5 0.5 A - 5 V - 0.5 W - IP44 (ingress protection) | IK10 (impact resistance) | CE | FCC | UKCA  
**Energy rating** : G  
Powered by Smart & Green



0.53 kg

### technical drawing

## Technical description

Materials 1

Electronic components - technical nature and operation 2

Lighting mood 3

Power supply 4

Additional technical information and Energy rating 5

## SYMBOLS

### RECOMMENDED USE



Indoor use

### IPAC



Anti-corrosion protection index



Optional additional anti-corrosion treatment

### COLOURS



No. of available colours for the product

### FURNITURE CHARACTERISTICS



Requires assembly

### LIGHT CHARACTERISTICS



Bluetooth



USB



Fermob magnet



Charging base



Plug type



Rechargeable Battery



Battery operated



Wire power supply

3410 - LAMP H.24 CM  
DESIGN BY TRISTAN LOHNER

DOMESTIC | PROFESSIONAL | INTENSIVE



Polyethylene diffuser

Aluminum frame

ABS base

Technology: integrated LED - Luminous flux: 70 lm

Switch type: push button

Function of the switch: change the light temperature (long click, 3 s),  
change the brightness (short click, 1 s)

Lighting mood:

Position 1 cool white (6000°K) 100% brightness

Position 2 cool white (6000°K) 50% brightness

Position 3 warm white (3000°K) 100% brightness

Position 4 warm white (3000°K) 50% brightness

Type of power supply: battery - Min. Battery life (100%): 7 h

Battery use cycle: 300 cycles

Recharge time: 3h - Type of recharge: USB, cable (supplied) 1 m

Bypass to prevent battery damage during wired use

0.5 A - 5 V - 0.5 W - IP54 (ingress protection) | IK 10 (impact resistance) | CE | FCC | UKCA

Energy rating: F

Powered by Smart & Green

Compatible with:

WALL LIGHT BRACKET - APLÔ

SUSPENSION STRAP - APLÔ

MAGNETIC BASE - APLÔ

UPRIGHT STAND - APLÔ



0.37 kg

341014 Nutmeg  
341020 Red Ochre  
341021 Acapulco Blue  
341047 Anthracite

341073 Honey  
341082 Cactus  
3410B9 Black Cherry  
3410A5 Clay Grey



APLÔ

# aplô

**MUCH MORE THAN JUST A COLLECTION,  
A REAL LIGHTING CONCEPT !**

With its **clever accessories**, the H.24 Aplô lamp offers a **multitude of lighting solutions**, both indoors and outdoors.

This **wireless LED lamp**, with its clear-cut design, is a concentrate of knowhow: it meets standards of solidity and resistance to outdoor conditions, it's fast charging, and has a long autonomy, with multi-temperature and intensity light power.



## PORTABLE LAMP



## TABLE LAMP



## WALL LAMP



## HANGING LAMP



## READING LAMP

APLÔ IS A **SMART AND MOBILE**  
LIGHTING SOLUTION

THAT MEETS ALL THE NEEDS OF EVERYDAY LIFE!

Watch  
our video



# APLÔ

3480 - UPRIGHT STAND  
DESIGN BY TRISTAN LOHNER



Aluminium frame  
ABS base  
Compatible product fastening type: screwed to the lamp base thanks to a quarter-turn system  
Compatible with:  
LAMP H24 - APLÔ

- |        |  |               |        |  |              |
|--------|--|---------------|--------|--|--------------|
| 348021 |  | Acapulco Blue | 3480C6 |  | Honey        |
| 348047 |  | Anthracite    | 3480B9 |  | Black Cherry |
| 348082 |  | Cactus        | 3480A5 |  | Clay Grey    |



Watch our video



3450 - MAGNETIC BASE  
DESIGN BY TRISTAN LOHNER



Aluminium frame  
ABS base  
Compatible product fastening type: screwed to the lamp base thanks to a quarter-turn system  
Compatible with:  
LAMP H24 - APLÔ

- |        |  |               |        |  |              |
|--------|--|---------------|--------|--|--------------|
| 345014 |  | Nutmeg        | 345073 |  | Honey        |
| 345020 |  | Red Ochre     | 345082 |  | Cactus       |
| 345021 |  | Acapulco Blue | 3450B9 |  | Black Cherry |
| 345047 |  | Anthracite    | 3450A5 |  | Clay Grey    |

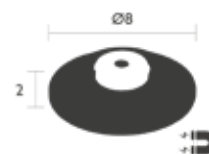

0.072 kg

3460 - WALL LIGHT BRACKET  
DESIGN BY TRISTAN LOHNER



Aluminium frame  
Compatible product fastening type: screwed to the lamp base thanks to a quarter-turn system  
Type of fastening: adhesive (double-sided, included) or screw-in (screws not included) wall bracket  
Compatible with:  
LAMP H24 - APLÔ

- |        |  |               |        |  |              |
|--------|--|---------------|--------|--|--------------|
| 346014 |  | Nutmeg        | 346073 |  | Honey        |
| 346020 |  | Red Ochre     | 346082 |  | Cactus       |
| 346021 |  | Acapulco Blue | 3460B9 |  | Black Cherry |
| 346047 |  | Anthracite    | 3460A5 |  | Clay Grey    |

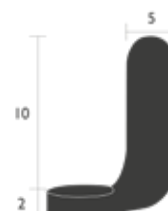

0.13 kg

3470 - SUSPENSION STRAP  
DESIGN BY TRISTAN LOHNER



Aluminium frame  
Compatible product fastening type: screwed to the lamp base thanks to a quarter-turn system  
Polyester strap (grey), with ABS adjustment loop  
Compatible with:  
LAMP H24 - APLÔ

- |        |  |               |        |  |              |
|--------|--|---------------|--------|--|--------------|
| 347020 |  | Red Ochre     | 347073 |  | Honey        |
| 347014 |  | Nutmeg        | 347082 |  | Cactus       |
| 347021 |  | Acapulco Blue | 3470B9 |  | Black Cherry |
| 347047 |  | Anthracite    | 3470A5 |  | Clay Grey    |



0.06 kg





# BALAD

3602 - SET OF 3 LAMPS H.12 CM

DESIGN BY TRISTAN LOHNER

DOMESTIC | PROFESSIONAL | INTENSIVE



Polyethylene diffuser

Aluminium frame

ABS base

Technology: integrated LED - Luminous flux: 20 lm

Switch type: push button

Function of the switch: change the light temperature & brightness (short click, 1 s), OFF (long click, 3 s)

Lighting mood:

Position 1 cool white (6000°K) 100% brightness

Position 2 neutral white (4000°K) 100% brightness

Position 3 candle-style warm white (2300°K) flickering

Type of power supply: battery - Min. Battery life (100%): 10 h

Battery use cycle: 500 cycles

Recharge time: 4h - Type of recharge: USB, cable (supplied) 1,5m

Bypass to prevent battery damage during wired use

0.25 A - 5 V - 0.3 W | IP44 (ingress protection) | IK 10 (impact resistance) | CE | FCC | UKCA

Powered by Smart & Green



0.15 kg

- 360282 ● Cactus
- 360214 ● Nutmeg
- 360273 ● Honey
- 360247 ● Anthracite

- 360221 ● Acapulco Blue
- 360220 ● Red Ochre
- 3602B9 ● Black Cherry
- 3602A5 ● Clay Grey

3612 - LAMP H.25 CM

DESIGN BY TRISTAN LOHNER

DOMESTIC | PROFESSIONAL | INTENSIVE



Polyethylene diffuser

Aluminium frame

ABS base

Technology: integrated LED - Luminous flux: 40 lm

Switch type: push button

Function of the switch: change the light temperature & brightness (short click, 1 s), OFF (long click, 3 s)

Lighting mood:

Position 1 cool white (6000°K) 100% brightness

Position 2 neutral white (4000°K) 100% brightness

Position 3 neutral white (4000°K) 50% brightness

Position 4 candle-style warm white (2300°K) flickering

Type of power supply: battery - Min. Battery life (100%): 7 h

Battery use cycle: 300 cycles

Recharge time: 5h - Type of recharge: USB, cable (supplied) 2m

Bypass to prevent battery damage during wired use

0.5 A - 5 V - 0.5 W | IP44 (ingress protection) | IK 10 (impact resistance) | CE | FCC | UKCA

Powered by Smart & Green



0.53 kg

- 361282 ● Cactus
- 361273 ● Honey
- 361247 ● Anthracite
- 361221 ● Acapulco Blue

- 361220 ● Red Ochre
- 3612B9 ● Black Cherry
- 3612A5 ● Clay Grey

# BALAD

3622 - LAMP H.38 CM  
 DESIGN BY TRISTAN LOHNER



Polyethylene diffuser  
 Aluminium frame  
 ABS base

Technology: integrated LED - Luminous flux: 150 lm

Switch type: push button

Function of the switch: change the light temperature & brightness (short click, 1 s), OFF (long click, 3 s)

Lighting mood:

Position 1 cool white (6000°K) 100% brightness

Position 2 cool white (6000°K) 50% brightness

Position 3 neutral white (4000°K) 100% brightness

Position 4 neutral white (4000°K) 50% brightness

Position 5 candle-style warm white (2300°K) flickering

Type of power supply: battery - Min. Battery life (100%) 9 h

Battery use cycle: 300 cycles

Recharge time: 7h - Type of recharge: USB, cable (supplied) 2m

Bypass to prevent battery damage during wired use

2 A - 5 V - 2.5 W | IP44 (ingress protection) | IK 10 (impact resistance) | CE | FCC | UKCA

Energy rating: E

Powered by Smart & Green



1.21 kg

- |        |  |               |        |  |              |
|--------|--|---------------|--------|--|--------------|
| 362282 |  | Cactus        | 362220 |  | Red Ochre    |
| 362273 |  | Honey         | 3622B9 |  | Black Cherry |
| 362247 |  | Anthracite    | 3622A5 |  | Clay Grey    |
| 362221 |  | Acapulco Blue |        |  |              |



BALAD

# BALAD

## 3632 - SPIKE STAND DESIGN BY TRISTAN LOHNER



Steel wire frame  
Steel clip on the ball joint system, with protective rubber pads  
Compatible with:  
LAMP H.25 CM - BALAD  
LAMP H.38 CM - BALAD

- |                        |                       |
|------------------------|-----------------------|
| 363282 ● Cactus        | 3632B9 ● Black Cherry |
| 363247 ● Anthracite    | 3632A5 ● Clay Grey    |
| 363221 ● Acapulco Blue | 3632C6 ● Honey        |
| 363220 ● Red Ochre     |                       |



## 3631 - UPRIGHT STAND DESIGN BY TRISTAN LOHNER



Steel wire frame  
Steel ballast  
Steel clip with protective rubber pads  
Compatible with:  
LAMP H.25 CM - BALAD  
LAMP H.38 CM - BALAD

- |                        |                       |
|------------------------|-----------------------|
| 363182 ● Cactus        | 3631B9 ● Black Cherry |
| 363147 ● Anthracite    | 3631A5 ● Clay Grey    |
| 363121 ● Acapulco Blue | 3631C6 ● Honey        |
| 363120 ● Red Ochre     |                       |

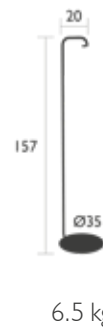

## 3630 - OFFSET STAND DESIGN BY TRISTAN LOHNER

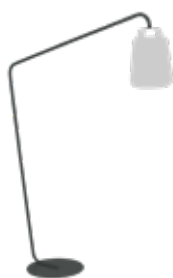

Steel wire frame  
Steel ballast  
Steel clip, with protective rubber pads  
Compatible with:  
LAMP H.38 CM - BALAD  
LAMP H.25 CM - BALAD

- |                        |                       |
|------------------------|-----------------------|
| 363082 ● Cactus        | 3630B9 ● Black Cherry |
| 363047 ● Anthracite    | 3630A5 ● Clay Grey    |
| 363021 ● Acapulco Blue | 3630C6 ● Honey        |
| 363020 ● Red Ochre     |                       |



Recommendations for appropriate installations:

**Choose Balad H.25 cm with:**



**Choose Balad H.38 cm with:**





BALAD

LIGHTING

# BALAD

365100 - SET OF 3 LAMPS BAMBOO H.12 CM

DESIGN BY TRISTAN LOHNER



Polyethylene diffuser  
Bamboo frame  
ABS base

Technology: integrated LED - Luminous flux: 20 lm

Switch type: push button

Function of the switch: change the light temperature & brightness (short click, 1 s), OFF (long click, 3 s)

Lighting mood:

Position 1 cool white (6000°K) 100% brightness

Position 2 neutral white (4000°K) 100% brightness

Position 3 candle-style warm white (2300°K) flickering

Type of power supply: battery - Min. Battery life (100%): 10 h

Battery use cycle: 500 cycles

Recharge time: 4h - Type of recharge: USB, cable (supplied) 1,5m

Bypass to prevent battery damage during wired use

0.25 A - 5 V - 0.3 W - IP44 (ingress protection) | IK 10 (impact resistance) | CE | FCC | UKCA

Powered by Smart & Green



0.13 kg

365200 - LAMP BAMBOO H.25 CM

DESIGN BY TRISTAN LOHNER



Polyethylene diffuser  
Bamboo frame  
ABS base

Technology: integrated LED - Luminous flux: 40 lm

Switch type: push button

Function of the switch: change the light temperature & brightness (short click, 1 s), OFF (long click, 3 s)

Lighting mood:

Position 1 cool white (6000°K) 100% brightness

Position 2 neutral white (4000°K) 100% brightness

Position 3 neutral white (4000°K) 50% brightness

Position 4 candle-style warm white (2300°K) flickering

Type of power supply: battery - Min. Battery life (100%): 7 h

Battery use cycle: 300 cycles

Recharge time: 5h - Type of recharge: USB, cable (supplied) 2m

Bypass to prevent battery damage during wired use

0.5 A - 5 V - 0.5 W - IP44 (ingress protection) | IK 10 (impact resistance) | CE | FCC | UKCA

Powered by Smart & Green



0.47 kg

# BALAD

365300 - LAMP BAMBOO H.38 CM

DESIGN BY TRISTAN LOHNER



Polyethylene diffuser

Bamboo frame

ABS base

Technology: integrated LED - Luminous flux: 150 lm

Switch type: push button

Function of the switch: change the light temperature & brightness (short click, 1 s), OFF (long click, 3 s)

Lighting mood:

Position 1 cool white (6000°K) 100% brightness

Position 2 cool white (6000°K) 50% brightness

Position 3 neutral white (4000°K) 100% brightness

Position 4 neutral white (4000°K) 50% brightness

Position 5 candle-style warm white (2300°K) flickering

Type of power supply: battery - Min. Battery life (100%): 9 h

Battery use cycle: 300 cycles

Recharge time: 7h - Type of recharge: USB, cable (supplied) 2m

Bypass to prevent battery damage during wired use

2 A - 5 V - 2.5 W - IP44 (ingress protection) | IK 10 (impact resistance) | CE | FCC | UKCA

Energy rating: E

Powered by Smart & Green



1.08 kg





# FERMOB, A RANGE OF LIGHTING

INNOVATIVE AND CONNECTIBLE



Over the last few years, Fermob has become the **leading brand in the world of autonomous connectible lighting.**

To work with a variety of lifestyles, the Fermob catalogue offers a **decorative and intelligent solution using Bluetooth technology.**

## LUDO,

### the Fermob smart switch

A combination of technology to control the lighting atmosphere provided by all Fermob smart lights.

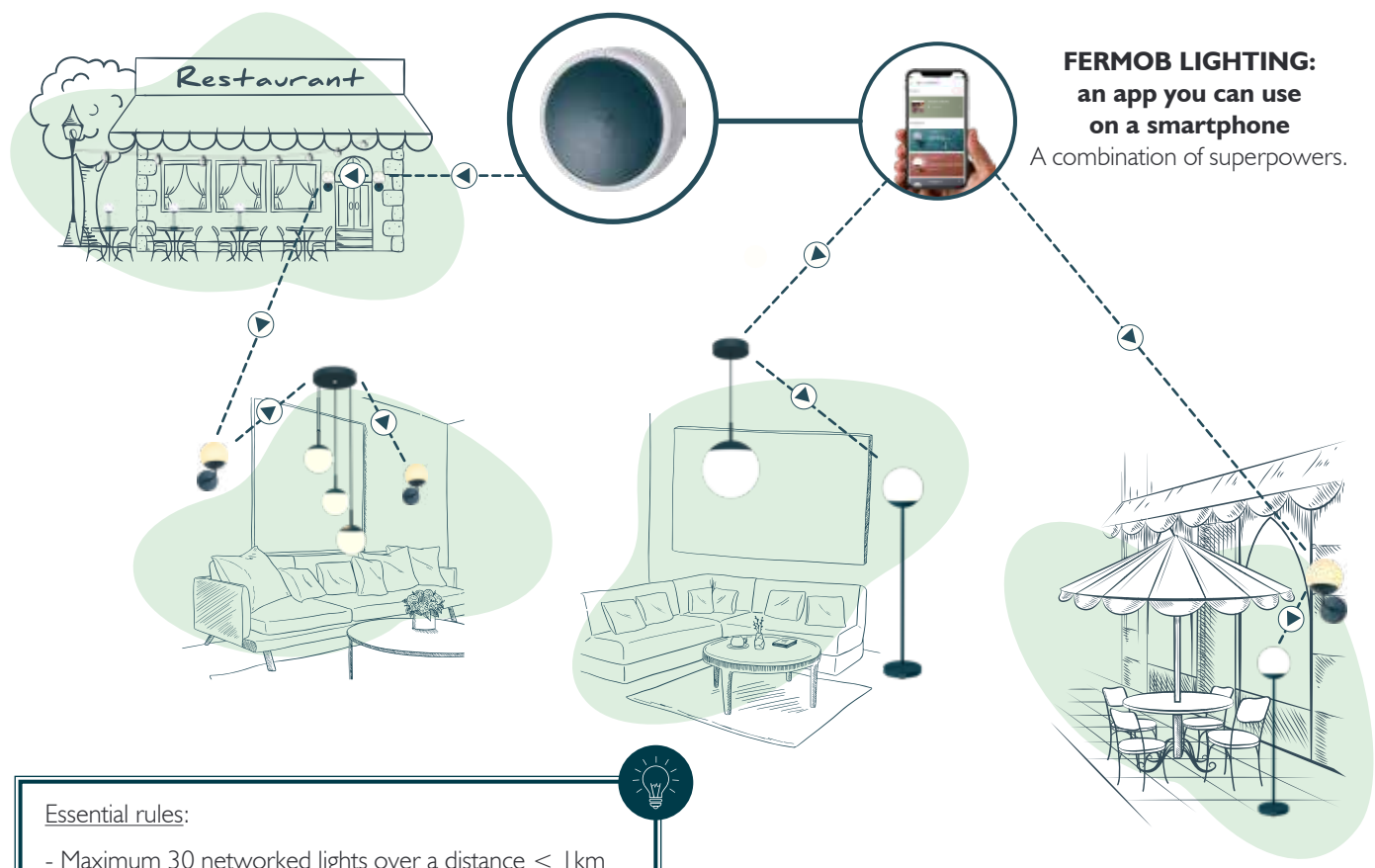

### FERMOB LIGHTING: an app you can use on a smartphone

A combination of superpowers.

#### Essential rules:

- Maximum 30 networked lights over a distance < 1 km
- Distance from smartphone to light < 10m
- Distance from switch to light < 15m
- Distance between lights < 10m
- No obstructions (e.g. wall)



## WHAT ARE THE FEATURES OF THE FERMOB LIGHTING APP?

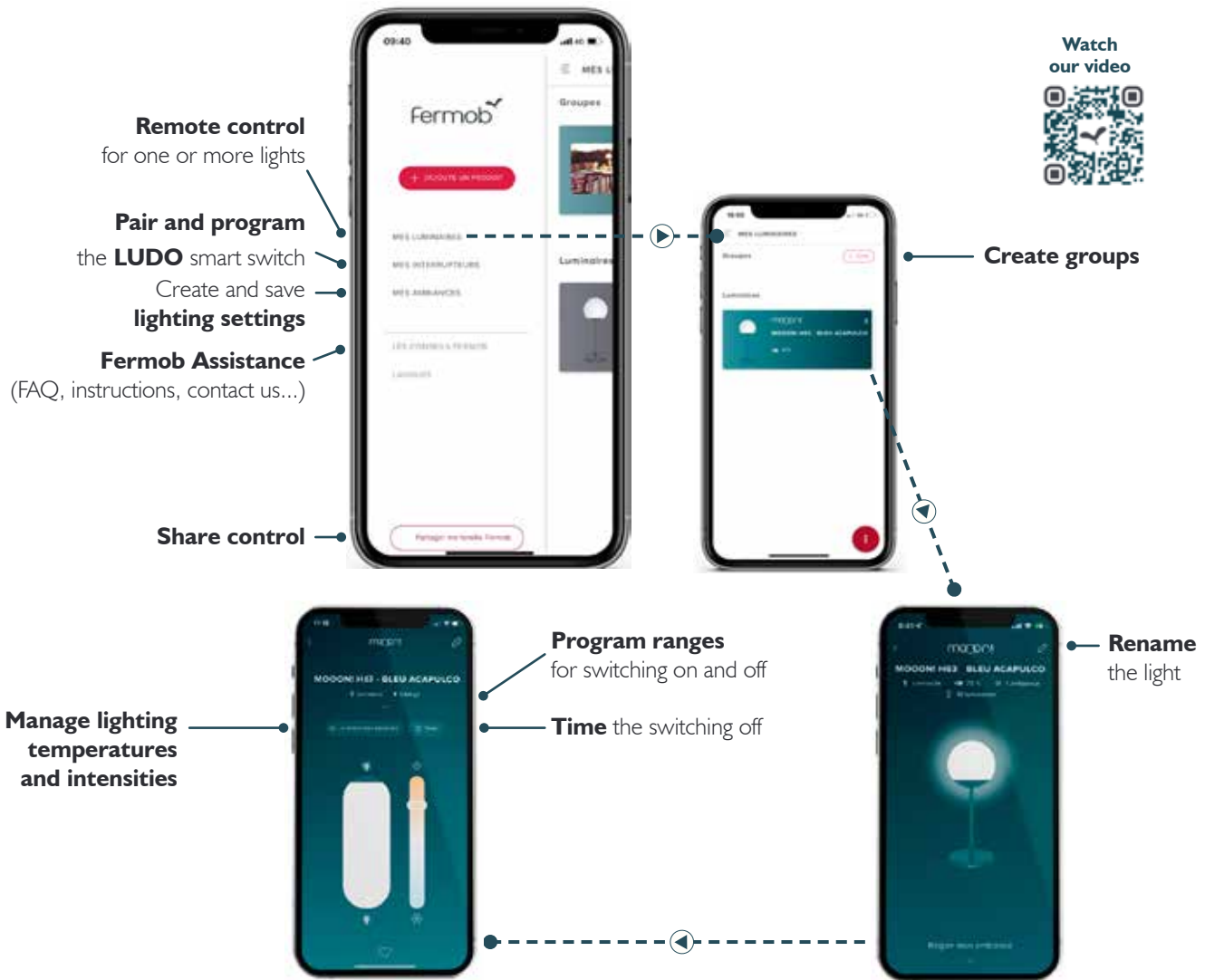

The FERMOb Lighting app is compatible with all smartphones equipped with Bluetooth. The app is updated regularly, as products are launched. **MAKE SURE YOU UPDATE IT!**



### Any questions?

Go to the FERMOb Lighting FAQs on [www.fermob.com](http://www.fermob.com) or directly from the app.

## A LOOK AT FERMOB SMART LIGHTS



**FERMOB SMART LIGHTS OFFER A UNIQUE CUSTOMISED EXPERIENCE, ACCESSIBLE TO EVERYONE.**



# HOOPIK

3503 - STRING LIGHTS LI 200 CM – TYPE J

DESIGN BY J.MAZOYER-DO

DOMESTIC | PROFESSIONAL | INTENSIVE



Polycarbonate diffuser

ABS frame

Technology: integrated LED - Luminous flux: 960 lm

Switch type: touch-activated dimmer

Function of the switch: ON/OFF (short click, 1s), brightness variation

Lighting mood:

Position 1 warm white (3000°K) dimmer switch (10 to 100%)

Lighting mood via Bluetooth:

White light variable from 4000°K to 2700°K & dimmer switch (10% to 100%)

Type of power supply: mains - Plug type : Plug type J (Switzerland, Liechtenstein)

0.24 A - 230 V - 25 W - Lighting cable: 6.20 metres (8 rings)

+ 6-metres main cable

IP54 (ingress protection) | IK 6 (impact resistance) | CE

Energy rating: F

Powered by Smart & Green

Compatible with:

FERMOB LIGHTING APPLICATION - FERMOB LIGHTING

SMART SWITCH - LUDO

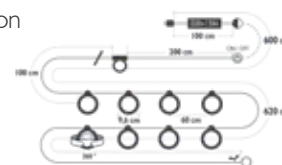

2.2 kg

350321 ● Acapulco Blue  
350320 ● Red Ochre

350382 ● Cactus  
3503B9 ● Black Cherry

hoopik  
LI200

**MUCH MORE THAN A GARLAND...**

**HOOPIK LI200** is a fully fledged **aerial lighting solution.**

It consists of a 12-metre matt black cable, including a 6-metre hanging cable, plus 8 LED spotlights that are adjustable through 360° and 2 hook mechanisms, one at each end.

The dimmer switch, which is easy to access once installed, means it's equally suited to both a muted lounge area and a large, brightly lit table.

What's more, it's equipped with Bluetooth technology and can be controlled remotely with the Fermob Lighting app or the Ludo connected outdoor switch.

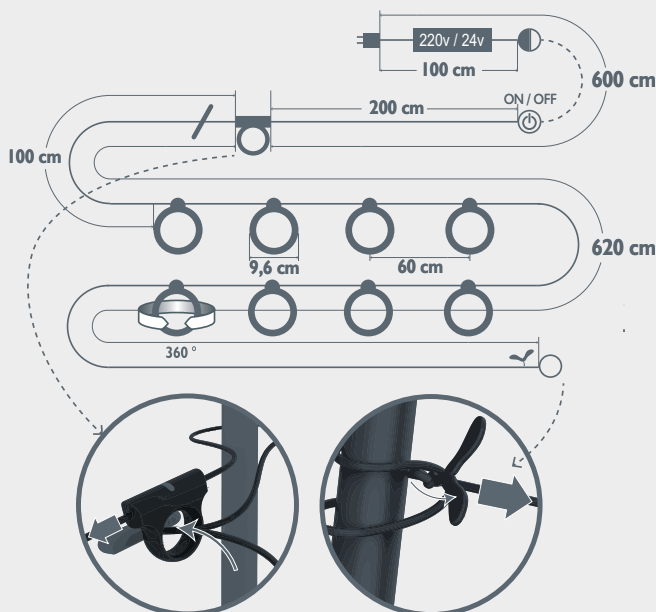

# HOOPIK

3510 - LAMP Ø24 CM  
DESIGN BY J.MAZOYER-DO



Polycarbonate diffuser  
Aluminium frame  
ABS Base  
Technology: integrated LED - Luminous flux: 200 lm  
Switch type: touch-activated dimmer  
Function of the switch: change the brightness (10 to 100%, click 4 s),  
change the light temperature (double short click),  
ON/OFF (short click, 1s)  
Lighting mood:  
Position 1 warm white (2700°K) dimmer switch (10 to 100%)  
Position 2 neutral white (4000°K) dimmer switch (10 to 100%)  
Type of power supply: battery - Min. Battery life (100%): 8 h  
Battery use cycle: 300 cycle  
Recharge time: 5h - Type of recharge: USB Fermob magnet  
1.5 m cable (provided)  
Bypass to prevent battery damage during wired use  
2 A - 5 V - 10 W - IP42 (Ingress protection) | IK 10 (Impact resistance) | CE | FCC | UKCA  
Energy rating: F  
Powered by Smart & Green

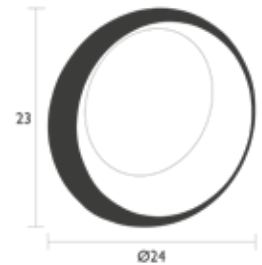

0,8 kg

- |        |  |               |        |  |              |
|--------|--|---------------|--------|--|--------------|
| 351021 |  | Acapulco Blue | 3510C7 |  | Grey lapilli |
| 351020 |  | Red Ochre     | 351042 |  | Liquorice    |





# INOUI

3304 - LIGHTING STOOL H.44 CM

DESIGN BY STUDIO FERMOB

DOMESTIC | PROFESSIONAL | INTENSIVE

10  
IPAC



Steel seat  
Polyethylene diffuser  
ABS base

Technology: integrated LED - Luminous flux: 250 lm

Switch type: push button

Function of the switch: change the light temperature (long click, 3 s), change the brightness (short click, 1 s), Reset Bluetooth pairing (click and hold for 10 s)

Lighting mood:

Position 1 cool white (6000°K) 50% brightness

Position 2 cool white (6000°K) 100% brightness

Position 3 warm white (3000°K) 50% brightness

Position 4 warm white (3000°K) 100% brightness

Lighting mood via Bluetooth:

White light variable from 6000°K to 3000°K & dimmer switch (10% to 100%)

Type of power supply: battery - Min. Battery life (100%) 9 h

Battery use cycle: 300 cycles

Recharge time: 4h - Type of recharge: ABS plastic charging base & transformer

I 10-230 Apv\*-24 Dpv\*\* IPX0, powered by mains electricity

Plug type: 4 plugs multi-type (J, K, G, F, L, E, B, I)

Bypass to prevent battery damage during wired use

1.5 A - 24 V - 7 W - IP54 (ingress protection) | IK 8 (impact resistance) | CE

Energy rating: G

Powered by Smart & Green

Compatible with:

APPLICATION FERMOB LIGHTING - FERMOB LIGHTING

SMART SWITCH - LUDO

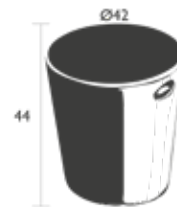

5 kg

330421 Acapulco Blue

330420 Red Ochre

330447 Anthracite

3304B9 Black Cherry

330482 Cactus



INOUI & MOON!

\* Alternating power volt / \*\*Direct power volt

# LUDO

3390 - SMART SWITCH  
DESIGN BY STUDIO FERMOB



Aluminum frame  
Base ABS  
Switch type: push button  
Function of the switch: change the light temperature (click 1 s),  
Reset Bluetooth pairing (click and hold for 10 s), change the brightness  
(10 to 100%, click 4 s), ON/OFF (short click, 1 s)  
Lighting mood:  
Position 1 cool white (6000°K) 100% brightness  
Position 2 warm white (3000°K) 100% brightness  
Type of fastening: magnetic, adhesive (double-sided, included) or screw-in  
(screws not included) thanks to a white wall mount  
Type of power supply: pile - 0.5 A - 3 V  
IP54 (ingress protection) | IK 10 (impact resistance) | CE  
*Powered by Smart & Green*  
Compatible with:  
STRING LIGHTS LI 200 CM – TYPE E & F - HOOPIK  
STRING LIGHTS LI 200 CM – TYPE I - HOOPIK  
STRING LIGHTS LI 200 CM – TYPE J - HOOPIK  
LIGHTING STOOL H.44 CM - INOUÏ  
WALL LIGHT Ø15 CM - MOOON!  
LAMP H.63 CM - MOOON!  
LAMP H.134 CM - MOOON!  
TRIPLE PENDANT LIGHTS Ø15 CM - MOOON!  
PENDANT LIGHTS 25 CM - MOOON!

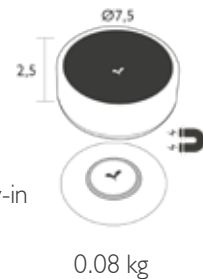

339082 Cactus  
339047 Anthracite

339021 Acapulco Blue



**LUDO THE SMART SWITCH IN AND OUTDOOR**

SHORT CLICK  
VARY COLOUR TEMPERATURE.

LONG CLICK  
VARY BRIGHTNESS.

# MOON!

5303 - LAMP H.41 CM  
DESIGN BY TRISTAN LOHNER



Polyethylene diffuser  
Aluminium frame  
ABS base

**Technology:** integrated LED - **Luminous flux:** 150 lm

**Switch type:** dimmer

**Function of the switch:** change the brightness (10 to 100%, click 4 s),  
change the light temperature (double short click), ON/OFF (short click, 1s)

**Lighting mood:**

Position 1 cool white (6000°K) dimmer switch (10 to 100%)

Position 2 warm white (3000°K) dimmer switch (10 to 100%)

**Type of power supply:** battery - **Min. Battery life (100%):** 8 h

**Battery use cycle:** 300 cycles

**Recharge time:** 7h - **Type of recharge:** USB, cable (supplied) 2m

Bypass to prevent battery damage during wired use

2 A - 5 V - 2.5 W - IP44 (ingress protection) | IK 10 (impact resistance) | CE | FCC | UKCA

**Energy rating:** F

Powered by Smart & Green



0.7 kg

- 530382 ● Cactus
- 530373 ● Honey
- 530314 ● Nutmeg
- 530347 ● Anthracite

- 530321 ● Acapulco Blue
- 530320 ● Red Ochre
- 5303A5 ● Clay Grey
- 5303B9 ● Black Cherry

5304 - LAMP H.41 MAX  
DESIGN BY TRISTAN LOHNER



Glass diffuser  
Aluminium frame  
ABS base

**Technology:** integrated LED

**Luminous flux on battery:** 200 lm - **Luminous flux on mains:** 300 lm

**Switch type:** touch-activated dimmer

**Function of the switch:** change the brightness (10 to 100%, click 4 s),  
change the light temperature (double short click), ON/OFF (short click, 1s)

**Lighting mood:**

Position 1 warm white (2700°K) dimmer switch (10 to 100%)

Position 2 neutral white (4000°K) dimmer switch (10 to 100%)

**Min. Battery life (100%):** 7 h - **Battery use cycle:** 300 cycles

**Recharge time:** 7h - **Type of recharge:** USB Fermob magnet – 1.5 m cable (provided)

Bypass to prevent battery damage during wired use

2 A - 5 V - 3 W - IP44 (ingress protection) | IK 0 (impact resistance) | CE | FCC

**Energy rating:** F

Powered by Smart & Green



1 kg

- 5304B9 ● Black Cherry
- 530482 ● Cactus

- 530421 ● Acapulco Blue
- 530447 ● Anthracite

Watch our video



Fermob  
magnet



- Charging system
- Practical & easy to use
- Identifiable (due to samara)





	LAMP H.41 MAX	LAMP H.41
Diffuser	Glass	Polyethylene
Lighting power	200 to 300 lm	150 lm
Colour temperatures	2700°K + 4000°K	3000°K + 6000°K
Switch	Touch - activated dimmer	Dimmer
Recharge	USB induction with its Fermob magnet	USB
Battery life	7h	8h



# MOON!

5320 - LAMP H.63 CM  
DESIGN BY TRISTAN LOHNER



Polyethylene diffuser  
Aluminium frame  
ABS base

Technology: integrated LED - Luminous flux: 500 lm

Switch type: touch-activated

Function of the switch: change the light temperature (long click, 3 s),  
change the brightness (short click, 1 s), Reset Bluetooth pairing  
(click and hold for 10 s)

Lighting mood:

Position 1 cool white (6000°K) 50% brightness

Position 2 cool white (6000°K) 100% brightness

Position 3 warm white (3000°K) 50% brightness

Position 4 warm white (3000°K) 100% brightness

Lighting mood via Bluetooth:

White light variable from 6000°K to 3000°K & dimmer switch (10% to 100%)

Type of power supply: battery - Min. Battery life (100%) 7 h

Battery use cycle: 300 cycles

Recharge time: 4h - Type of recharge: ABS plastic charging base & transformer

I 10-230 Apv\*-24 Dpv\*\* IPX0, powered by mains electricity

Plug type : 4 plugs multi-type (J, K, G, F, L, E, B, I)

Bypass to prevent battery damage during wired use

1.5 A - 24 V - 7 W - IP44 (ingress protection) | IK 10 (impact resistance) | CE | FCC

Energy rating: F

Powered by Smart & Green

Compatible with:

FERMOB LIGHTING APPLICATION - FERMOB LIGHTING

SMART SWITCH - LUDO

532082 ● Cactus  
5320B9 ● Black Cherry  
532047 ● Anthracite

532021 ● Acapulco Blue  
532020 ● Red Ochre



2.65 kg



MOON!



MOON!

\* Alternating power volt / \*\*Direct power volt

# MOON!

5310 - LAMP H.134 CM  
DESIGN BY TRISTAN LOHNER



Polyethylene diffuser  
Aluminium frame  
ABS base

Technology: integrated LED - Luminous flux: 500 lm

Switch type: touch-activated

Function of the switch: change the light temperature (long click, 3 s),  
change the brightness (short click, 1 s), Reset Bluetooth pairing  
(click and hold for 10 s)

Lighting mood:

- Position 1 cool white (6000°K) 50% brightness
- Position 2 cool white (6000°K) 100% brightness
- Position 3 warm white (3000°K) 50% brightness
- Position 4 warm white (3000°K) 100% brightness

Lighting mood via Bluetooth:

White light variable from 6000°K to 3000°K & dimmer switch (10% to 100%)

Type of power supply: battery - Min. Battery life (100%) 7 h

Battery use cycle: 300 cycles

Recharge time: 4h - Type of recharge: ABS plastic charging base & transformer

I 10-230 Apv\*-24 Dpv\*\* IPX0, powered by mains electricity

Plug type: 4 plugs multi-type (J, K, G, F, L, E, B, I)

Bypass to prevent battery damage during wired use

1.5 A - 24 V - 7 W - IP44 (ingress protection) | IK 10 (impact resistance) | CE | FCC | UKCA

Energy rating: F

Powered by Smart & Green

Compatible with:

FERMOB LIGHTING APPLICATION - FERMOB LIGHTING

SMART SWITCH - LUDO

- 531082 Cactus
- 531089 Black Cherry
- 531047 Anthracite

- 531021 Acapulco Blue
- 531020 Red Ochre

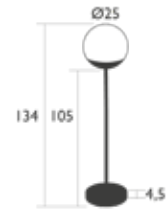

5.4 kg



\* Alternating power volt / \*\*Direct power volt

# MOON!

5330 - WALL LIGHT Ø15 CM

DESIGN BY TRISTAN LOHNER



Glass diffuser  
Aluminium frame  
Recycled ABS base  
Technology: integrated LED - Luminous flux: 400 lm

Lighting mood:

Position I warm white (3000°K) 100% brightness

Lighting scenario via Bluetooth:

White light variable from 6000°K to 3000°K & dimmer switch (10% to 100%)

Type of fastening: Quick'n'click for fast installation with a single quarter turn (integrated spirit level and detachable base)

Type of power supply: wall mount | 0.24 A - 230 V - 8 W  
IP54 (ingress protection) | IK 0 (impact resistance) | CE | UKCA

Energy rating: F

Powered by Smart & Green

Compatible with:

FERMOB LIGHTING APPLICATION - FERMOB LIGHTING

SMART SWITCH - LUDO

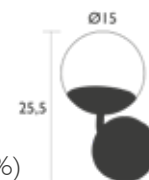

0.9 kg

533082 ● Cactus  
533047 ● Anthracite  
533021 ● Acapulco Blue

533020 ● Red Ochre  
5330B9 ● Black Cherry

Watch our video



MOON!



## quick'n clic

Easy installation



Watch our video



MOON!



LIGHTING

# MOON!

5340 - TRIPLE PENDANT LIGHTS Ø15 CM

DESIGN BY TRISTAN LOHNER



Glass diffuser  
 Aluminium frame  
 Recycled ABS base  
Technology: integrated LED - Luminous flux: 1050 lm  
Function of the switch: change the light temperature (click 1s),  
 change the brightness (10 to 100%, click 4 s), ON/OFF (short click, 1s)  
Lighting mood:  
 Position 1 cool white (6000°K) dimmer switch (10 to 100%)  
 Position 2 warm white (3000°K) dimmer switch (10 to 100%)  
Lighting scenario via Bluetooth:  
 White light variable from 6000°K to 3000°K & dimmer switch (10% to 100%)  
Type of fastening: Quick'n'click for fast installation with a single quarter  
 turn (detachable base)  
Type of power supply: wired  
 Adjustable cable  
 0.19 A - 230 V - 17 W - IP42 (ingress protection) | IK 0 (impact resistance) | UKCA  
Energy rating: E  
 Powered by Smart & Green  
Compatible with:  
 FERMOB LIGHTING APPLICATION - FERMOB LIGHTING  
 SMART SWITCH - LUDO

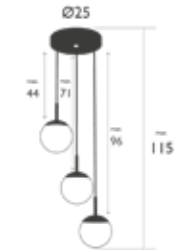

2.5 kg

- 5340B9 ● Black Cherry
- 534021 ● Acapulco Blue
- 534082 ● Cactus
- 534047 ● Anthracite



5350 - PENDANT LIGHTS Ø25 CM

DESIGN BY TRISTAN LOHNER



Glass diffuser  
 Aluminium frame  
 Recycled ABS base  
Technology: integrated LED - Luminous flux: 1000 lm  
Function of the switch: change the light temperature (click 1s),  
 change the brightness (10 to 100%, click 4 s), ON/OFF (short click, 1s)  
Lighting mood:  
 Position 1 cool white (6000°K) dimmer switch (10 to 100%)  
 Position 2 warm white (3000°K) dimmer switch (10 to 100%)  
Lighting scenario via Bluetooth:  
 White light variable from 6000°K to 3000°K & dimmer switch (10% to 100%)  
Type of fastening: Quick'n'click for fast installation with a single quarter  
 turn (detachable base)  
Type of power supply: wired  
 Adjustable cable  
 0.19 A - 230 V - 15 W - IP42 (ingress protection) | IK 0 (impact resistance) | UKCA  
Energy rating: E  
 Powered by Smart & Green  
Compatible with:  
 FERMOB LIGHTING APPLICATION - FERMOB LIGHTING  
 SMART SWITCH - LUDO



2 kg

- 5350B9 ● Black Cherry
- 535021 ● Acapulco Blue
- 535082 ● Cactus
- 535047 ● Anthracite



# OTO

3960 - LAMP H.27 CM  
DESIGN BY STUDIO FERMOB



Polycarbonate diffuser  
Aluminium frame  
Recycled ABS base  
Technology : integrated LED - Luminous flux: 400 lm  
Switch type: touch-activated dimmer  
Function of the switch: change the brightness (10 to 100%, click 4 s), change the light temperature (double short click), ON/OFF (short click, 1s)

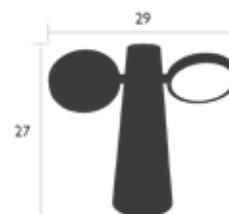

Lighting mood:  
Position 1 cool white (6000°K) dimmer switch (10 to 100%)  
Position 2 warm white (3000°K) dimmer switch (10 to 100%)  
Type of fastening: A metal buckle located underneath the lamp for hanging  
Type of power supply: battery - Min. Battery life (100%) 6 h  
Battery use cycle: 300 cycle  
Recharge time: 6 h - Type of recharge: USB Fermob magnet – 1.5 m cable (provided)  
Bypass to prevent battery damage during wired use  
2 A - 5 V - 6 W - IP54 (ingress protection) | IK 6 (impact resistance) | CE | FCC | UKCA  
Energy rating: F  
*Powered by Smart & Green*

1.1 kg

- |                        |                       |
|------------------------|-----------------------|
| 396021 ● Acapulco Blue | 3960B9 ● Black Cherry |
| 396082 ● Cactus        | 396047 ● Anthracite   |
| 396007 ● Lapilli Grey  | 396042 ● Liquorice    |
| 396020 ● Red ochre     | 3960A5 ● Clay Grey    |



Watch our video







# ULLI

3810 - LAMP H.30 CM  
 DESIGN BY STUDIO FERMOB

NEW

DOMESTIC | PROFESSIONAL | INTENSIVE



Polycarbonate diffuser  
 Aluminium frame  
 ABS Base

Technology: integrated LED - Luminous flux: 220 lm

Switch type: touch-activated dimmer

Function of the switch: change the light temperature (click 1s),  
 change the brightness (10 to 100%, click 4 s),  
 change the light temperature (double short click), ON/OFF (short click, 1s)

Lighting mood:

Position 1 warm white (3000°K) dimmer switch (10 to 100%)

Position 2 cool white (6000°K) dimmer switch (10 to 100%)

Type of power supply: battery - Min. Battery life (100%): 6 h

Battery use cycle: 300 cycle

Recharge time: 4h - Type of recharge : USB Fermob magnet – 1.5 m cable (provided)

Bypass to prevent battery damage during wired use

2 A - 5 V - 3 W - IP54 (Ingress protection) | IK 6 (Impact resistance) | CE | FCC | UKCA

Energy rating: F

Powered by Smart & Green



1.2 kg

381067  Poppy  
 381092  Deep blue

381002  Cedar green  
 3810C6  Honey

Watch our video



# PROFESSIONAL PROJECTS & SERVICES

## FERMOB CONTRACT

A DEDICATED CONTRACT DEPARTMENT FOR PROFESSIONAL PROJECTS

As professional outdoor spaces are the showcases of both private and public institutions, they must be **personalised** and **attractive**, and **thought must be given to their every aspect** - furniture, lighting, separators, parasols and decorative accessories - **to create uniquely styled, complete layouts for all professional outdoor spaces.**

**Professional markets are long-standing markets for the Fermob brand.**

The Bistro chair, created from the Simplex model (a Fermob patent dating back to 1889) used to be sold to lemonade sellers! Since then, our professional catalogue has grown to **400 pieces** across over **60 collections**, a large selection that doesn't even include adaptations and bespoke pieces.



MARIOTT HOTEL RENAISSANCE, BORDEAUX - FRANCE



HOTEL MOLITOR, PARIS - FRANCE

To coordinate our activity and offer the highest level of service, **team of 30 people within the Contract department is exclusively dedicated to consulting and professional projects**: layout advice, developing 2D/3D plans and 3D files for your mock-ups, special articles, customized services, installation and assembly.



TIDEHOUSE STUART - USA

## SUPPORTING YOU IN ALL YOUR PROJECTS

Architects, landscape designers, project retailers, designers and decorators play a key role in the choice of furniture for large layout projects. This is why Fermob supports them by keeping the documentation up to date (metal and colour charts, catalogues, technical documentation, etc.) and by providing them with 3D files for drawing up their layout plans for projects in the hotel and catering industry, for public spaces or office exteriors.

Find all our collections modeled on Pcon. **pCon**



APICIUS, PARIS - FRANCE

The Fermob Contract Unit team of interior designers and shop-fitters works in various fields such as the design of terraces, swimming pools/spas, balconies, rooftops, hotel rooms, entrance halls, public spaces, office exteriors, reception areas and waiting rooms, etc...

Its main missions are:

- Advice on projects and decoration (moodboards)
- Space optimization: design and production of 2D plans
- Proposals for complete layouts: design and production of 3D plans



HOTEL MOLITOR, PARIS - FRANCE

## BESPOKE PROJECTS : BE UNIQUE !

Our bespoke projects division is available to offer you products that meet with **specific requests related to your brand identity** (charters, logos, etc.) or to **particular functions or made-to-measure design requirements**.

- **Marking:** different types of logo, short texts or graphic design using either laser cutting or silk-screen printing on either metal or OTF.
- **Special colours:** RAL (lets you make finer distinctions between colours) or other colours on request.
- **Adaptations:** format modification, reinforcement, fireproofing on OTFs that allow it.
- **Attachments:** to the floor or by cable.
- **Textiles / Cushions:** The group's other know-how means that we can also offer you outdoor lighting, custom-made cushions and parasols in your colours.
- **Tailor-made furniture:** Because we offer an end-to-end production service in-house, we can develop metal products that meet your requirements. So use our tailor-made solutions to customize your outdoor equipment as you please, and let your clients enjoy a fine experience and unique moments.



GRAND HOTEL DIEU, LYON - FRANCE / DÉCOUPE LASER



VEUVE CLICQUOT - FRANCE / DÉCOUPE LASER



HOTEL MOLITOR, PARIS - FRANCE

# THE FURNITURE COLLECTION

	SILK-SCREEN PRINTING	LASER CUTTING	ATTACHMENTS BY CABLE	ATTACHMENT TO FLOOR	BALLAST	RAL Special	Special size	Other
<b>1900</b>	x	x	x	x		x	x	
<b>ADADESK</b>	x		x	x		x		
<b>ALIZÉ</b>								
<b>Sunlounger</b>	x		x	x		x		
<b>Low table</b>	x	x	x	x		x		
<b>BEBOP</b>	x	x	x	x		x	x	
<b>BELLEVIE</b>								
<b>Benches</b>	x		x	x	x	x	x	
<b>Chair V2</b>			x	x	x	x		
<b>Dining armchair, Sunlounger, Lounge</b>			x	x	x	x	x	Fabrics
<b>Tables</b>	x		x	x	x	x	x	
<b>Large low table</b>	x		x	x		x		
<b>Stool</b>	x		x	x	x	x	x	
<b>BISTRO</b>								
<b>Natural chair</b>			See pricelist			See pricelist		Engraving slats
<b>Classic chair</b>			See pricelist			See pricelist (except slats)		Engraving slats / Colour slats
<b>Duraflon chair</b>			See pricelist			See pricelist (except slats)		Engraving slats / Colour slats
<b>Metal seats</b>	x	x	x	x		x		
<b>Chaise longue</b>	x	x	x	x		x		
<b>Tables</b>	x	x	x	x		x	x	
<b>BOLDER</b>	x		x	x		x		
<b>COCOTTE</b>	x		x	x	x	x	x	
<b>CROISETTE</b>								
<b>Seats</b>					x			
<b>Table</b>	x		x	x		x		
<b>DUNE PREMIUM</b>								
	x		x	x		x		Two-tone or special OTF colour
<b>FACTO</b>								
	x	x	x	x		x	x	
<b>LOUISIANE</b>			x	x		x	x	
<b>LORETTE</b>								
			x	x		x	x	Laser pattern
<b>LUXEMBOURG</b>								
<b>Seats</b>	x	x	x	x	x	x		
<b>Tables</b>	x		x	x	x	x		
<b>Pedestal table</b>	x		x	x	x	x		
<b>MONCEAU</b>								
<b>Seats</b>	x	x	x	x	x	x		
<b>Tables</b>	x		x	x	x	x		
<b>OULALA</b>								
<b>Set of 3 nesting low tables</b>	x	x		x		x	x	Sold individually
<b>PÉTALE</b>								
	x		x	x		x	x	
<b>PICOLINO</b>								
	x			x		x		
<b>RESTO</b>								
	x		x	x		x		
<b>SIXTIES</b>								
<b>Seats</b>					x			
<b>Tables</b>	x		x	x	x	x		
<b>SO'O</b>								
	x		x	x		x		
<b>STRIPE</b>								
	x		x	x	x	x		
<b>STUDIE</b>								
	x		x	x	x	x		
<b>SURPRISING</b>								
<b>Metal</b>	x		x	x		x		
<b>Teak</b>			x	x		x		
<b>TERRAZZA</b>								
	x		x	x		x		Wheel

Other products on request.

Delivery time varies according to season and quantity - Please contact us.

## THE LIGHTING COLLECTIONS



Alcohol abuse is dangerous to health. Alcohol should be consumed in moderation.

### Veuve Clicquot by Fermob

- RAL Special
- Individual packaging of H12, screen printing, and special packaging

SPECIAL OPTIONS	RAL on metal	Cable colours	Screen printing on metal	Screen printing on diffuser	Cable length	Packaging	Laser cutting	Ground Mount	Packaging
<b>APLO</b>									
H24 lamp	x		x			x			x
Magnetic base	x					x			x
Wall light bracket	x					x			x
Hanging strap	x	x				x			x
Upright stand	x		To be confirmed					To be confirmed	
<b>BALAD</b>									
H12 lamp	x		x	To be confirmed		x			x
H12 Bamboo lamp			x	To be confirmed		x			x
H25 lamp	x		x	To be confirmed		x			x
H25 Bamboo lamp			x	To be confirmed		x			x
H38 lamp	x		x	To be confirmed		x			x
H38 Bamboo lamp			x	To be confirmed		x			x
Spike stand	x		x						
Upright stand	x		x					x	
Offset stand	x		x					x	
<b>HOOPIK</b>									
L1200 String Lights						x			
Ø24 lamp	x					x			x
<b>INOUI</b>									
H44 lighting stool	x		x			x	x		x
<b>LUDO</b>									
Smart switch	x					x			x
<b>MOON!</b>									
H41 lamp	x		x			x			x
H41 MAX lamp	x		x			x			x
H63 lamp	x		x			x			x
H134 lamp	x		x			x			x
Triple pendant light, Ø15	x	x			x	x			x
Pendant light, Ø25	x	x			x	x			x
Wall light Ø15	x					x			x
<b>OTO</b>									
H27 lamp	x					x			x
<b>ULLI</b>									
H30 lamp	x					x			x

Prices & Delivery times vary depending on season & quantity - Contact us for more information.



# GARDEN OFFICE

WORK AND FRESH AIR GO HAND IN HAND

“Garden Office” is a product line designed to create open-air offices, welcoming shared spaces, which favour discussions and encourage sharing between employees.

The Garden office concept includes a selection of product ranges:

- **Innovative ranges specifically developed for working outside: Adadesk, Bolder, etc.**
- **The brand’s leading models, redesigned with this specific use in mind...**

With **Luxembourg Work**, Fermob relies on its know-how and its flagship products to meet the requirements of these new work methods.

Fermob’s Luxembourg collection already includes the “dining”, “high version dining” and “lounge” ranges, to which will be added a fourth: the “work” range.

The new **“Luxembourg Work High Table”** will be easy to combine with other products from the Luxembourg range: bar stool, bar chair, high armchair (which are all part of the same product family).

The product will be complemented by a “mobile shelf” (vs. bag holder).





# ADADESK

3279 - ROCKING DESK  
DESIGN BY STUDIO FERMOB

NEW

DOMESTIC PROFESSIONAL INTENSIVE

10  
IPAC



Aluminium tubular frame  
Curved aluminium slats seat  
Aluminium sheet top



4.3 kg



ADADESK

PROFESSIONALS  
PROJECTS & SERVICES

# BOLDER

I050 - 2-SEATER ROUND TABLE WITH SEATS  
DESIGN BY STUDIO FERMOB



Tubular steel frame  
Curved sheet steel seat  
Steel sheet table top  
Ground fixation recommended  
Table: height-adjustable pads  
Available colours: see limited colour chart

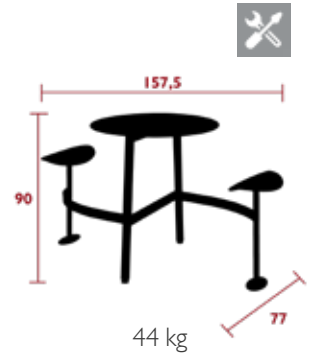

I053 - 3-SEATER MODULAR TABLE WITH SEATS  
DESIGN BY STUDIO FERMOB



Tubular steel frame  
Curved sheet steel seat  
Steel sheet table top  
Table top connection system  
Ground fixation recommended  
Table: height-adjustable pads  
Available colours: see limited colour chart

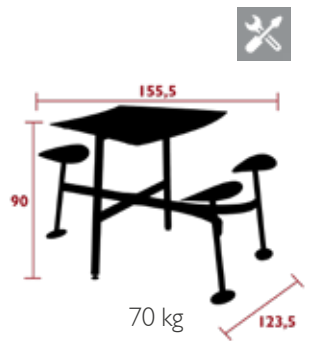

## ASSEMBLY SET

Please order an assembly set to link two 3-Seater modular tables (2893C)



Watch our video



# BOLDER

AN INFINITY OF COMPOSITIONS AVAILABLE ON REQUEST

## S-SHAPED COMPOSITION



258 x 648 x H 90 cm

6 3-seater modular tables  
5 assembly sets



## C-SHAPED COMPOSITION



463 x 531 x H 90 cm

9 3-seater modular tables  
8 assembly sets

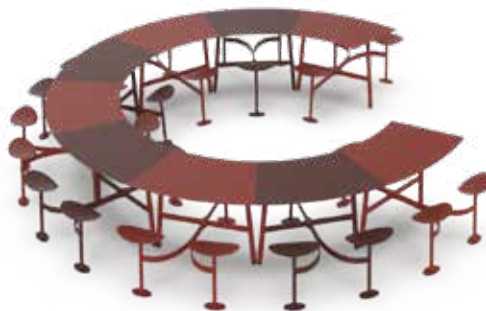

Suggestion for a Food Hall area: combine different heights of Bolder counters and tables to create a friendly, informal dining area

# BOLDER

I047 - HIGH STOOL  
DESIGN BY STUDIO FERMOB

NEW DOMESTIC PROFESSIONAL INTENSIVE 7 IPAC 24



Tubular steel frame  
Curved steel sheet seat  
Stainless steel protection on the footrest  
Available colours: see limited colour chart



9,5 kg



I057 - COUNTER  
DESIGN BY STUDIO FERMOB

NEW DOMESTIC PROFESSIONAL INTENSIVE 7 IPAC 24



Steel sheet table top  
Tubular steel base  
Flat steel cross-piece for footrest  
Height-adjustable pads  
Available colours: see limited colour chart  
Compatible with :  
CONNECTING TABLE TOP - ANGULAR - BOLDER



37 kg



## ASSEMBLY SET

Please order a connection kit to link two counters.



Watch our video



I058 - CONNECTING TABLE TOP - ANGULAR  
DESIGN BY STUDIO FERMOB

WORK IN PROGRESS NEW DOMESTIC PROFESSIONAL INTENSIVE 24



Steel sheet table top  
Connection system included  
Available colours: see limited colour chart  
Compatible with :  
COUNTER - BOLDER

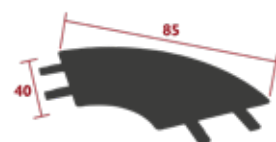

10 kg



# BOLDER

## AN INFINITY OF COMPOSITIONS AVAILABLE ON REQUEST

- Aligned in the same direction, the counters are perfect along a wall or a bay window. They can be faced in either direction depending on how the footrest is to be used.
- Offset from one another, the counters can define an area, separating it into different spaces for different uses



**360 x 40 x H 105 cm**

3 counters

2 assembly sets

- 100% modular, the Bolder counter and its corner connecting top can be combined in a multitude of arrangements for a wide variety of configurations

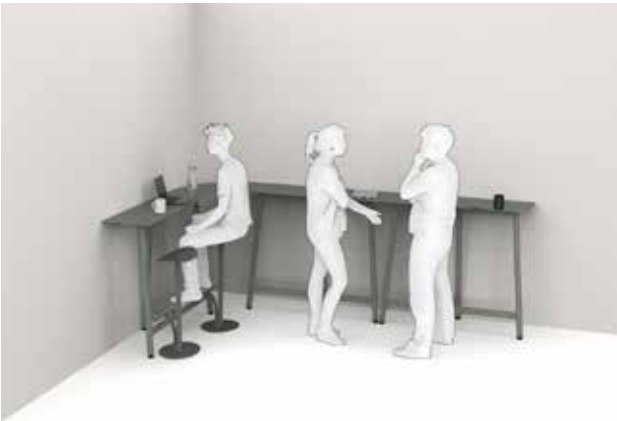

**300 x 180 cm**

3 counters

1 connecting table top

1 assembly set

**560 x 240 cm**

5 counters

2 connecting table tops

2 assembly sets

# KALAHARI

3627 - SHADED TABLE  
DESIGN BY STUDIO FERMOB

NEW DOMESTIC PROFESSIONAL INTENSIVE 6 IPAC 25



Steel sheet table top  
Steel tubular base  
Outdoor fabric solution-dyed acrylic



16 kg

3 POSITIONS



# LUXEMBOURG WORK

4143 - HIGH TABLE 126 X 73 CM

NEW DOMESTIC PROFESSIONAL INTENSIVE 9 IPAC 25



Aluminium sheet table top  
Aluminium tubular base  
Table top equipped with 2 cup holders  
Tubular aluminium cross-piece for footrest  
Delivered with a trinket tray and two handbag hooks  
Compatible with :  
TRINKET TRAY - LUXEMBOURG WORK



21 kg

4145 - TRINKET TRAY

NEW DOMESTIC PROFESSIONAL INTENSIVE 6<sup>7</sup> IPAC 25



Steel sheet  
Compatible with :  
HIGH TABLE 126 X 73 CM - LUXEMBOURG WORK  
HIGH TABLE 126 X 73 CM - LUXEMBOURG

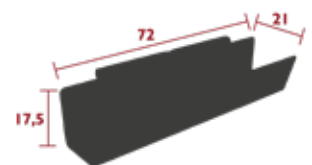

4 kg



Watch our video



# TROLLEYS

## 0190 - CHAIR TROLLEY

DESIGN BY STUDIO FERMOB



Steel tube frame  
Storage capacity: 36 folding chairs  
(Bistro, Dune, La Môme, Latitude, Plein Air)  
Takes up little space  
Delivered flat-packed  
Stainless steel screws  
4 wheels with brake

019008 ● Black



## 0191 - TABLE TROLLEY

DESIGN BY STUDIO FERMOB



Steel tube frame  
Storage capacity: 20 folding tables  
(Bistro and Floréal)  
Takes up little space  
Stainless steel screws  
Delivered flat-packed  
4 wheels with brake

019108 ● Black

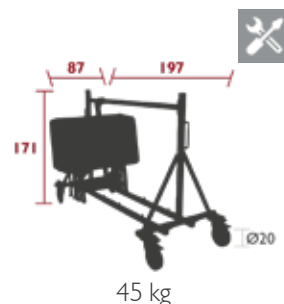

# HAND TROLLEY

## 4190 - HAND TROLLEY



Supports the following seats:  
- 7 x Luxembourg chairs/armchairs  
- 4 x Surprising chairs  
- 6 x Cadiz chairs/armchairs  
- 7 x Stripe chairs  
Delivered assembled with wheels (Ø 20 cm)

419042 ● Liquorice

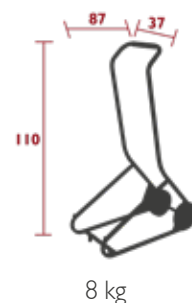

# COVERS

## 3150 - CHAIR & ARMCHAIR STACK COVER



Polyester fabric  
Max. storage capacity: 36 chairs and armchairs  
Cadiz, Facto, Lorette, Luxembourg®, Monceau, Stripe and Studie  
Do not use as a winter cover

315054 ● Light Grey

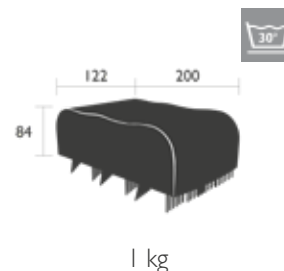

# PROTECTION & MAINTENANCE

## OUR CARE AND MAINTENANCE RECOMMENDATIONS

### DURING THE SEASON

- **In the open air:** design + material + surface treatment (anti-UV paint and moisture resistance) allow Fermob furniture to be left outside,
- **Clean your furniture regularly**, more frequently in places with high humidity and in salty environments near the sea,
- Use the **breathable, dirt-resistant protective covers** (Contract – stack covers) to protect solid-top tables, sunloungers and chairs from dead leaves, pine sap and bird droppings.
- Use the **water-repellent protective covers** (Bellevie).

### WINTER STORAGE

- To extend the lifespan of your garden furniture, we recommend storing it over **winter in a dry, well-ventilated place** where it will be **protected from impacts**, if at all possible,
- **Clean** and restore the Fermob products if necessary (rust remover / paint touch-up),
- **Place the tables** (and other products) **on leg risers** to create a slope that allows water to drain away,
- **Do not store anything on top of the furniture**, especially objects that may retain water and moisture (such as flower pots and trivets),
- **Do not store the tables stacked with the table tops together**, or the benches stacked with the seats together,
- Ideally, you should **rest your seats against the tables** rather than placing them upside down on top of them,
- **Store folding items of furniture in their folded state**, and under cover if possible,
- **Stack chairs / sun loungers** or other furniture, and store them **under cover** if possible,
- **Wash, then bring in the cushions** and store them away from dust and moisture,
- If you have to chain up your furniture, **use sheathed chains to prevent scratching**.



Never cover the furniture, especially with a non-breathable plastic tarpaulin that will retain moisture, to avoid paint discoloration and stains.







## PROTECTIVE COVER

What are the 2 types of protective cover available in the Fermob catalogue?

- **Protective cover for table, sunlounger and chair (Contract cover)**

Colour: Light Grey

Material: Polyamide or Polyester

**Breathable**, the covers protect the item of furniture from dirt (from dead leaves, pine sap, bird droppings, etc.) during the season.

**They allow you to protect your furnishings while creating an aeration system that allows water to drain.**

**Please note that these covers are in no way waterproof.**



**In order to avoid the stagnation of humidity and the appearance of rings, leg risers must be used to secure the tables, even when using a protective cover**

- **Protective covers for furniture Bellevie cushion**

Colour: Clay Grey with Black Cherry trim

Material: Polyamide with polyurethane coating

**Water-repellent**, the covers protect the cushions of items of furniture from inclement weather during the season.



**Caution: these 2 types of cover are not designed for winter storage, but to protect items of furniture during the season.**

## PROTECTING LIGHTS

### PROTECTION IN DAILY USE

Fermob lights are quality products that require a few use and storage precautions in order to preserve all their properties and thus extend their life to the maximum.

- **Store in a dry and ventilated area** when not in use,
- **Regularly clean** (more so in areas with high levels of humidity),
- **Recharge in a weatherproof environment** with a temperature between +0 and +40°C,
- **Only use the charging and power supply equipment provided,**
- **Do not let the lamp's battery run flat,**
- **Opt for frequent, short-duration charges.**



A battery's lifespan depends on several factors:

- The environment in which the product is used (temperature, humidity, etc.),
- The environment in which the product is charged (temperature, humidity, etc.).

### PROTECTION DURING WINTER/STORAGE

- **Store in a dry and ventilated area**
- **Clean and restore** as required,
- **Store your lamp with its battery partially charged, in a dry, well-ventilated spot,** sheltered from direct sunlight.

## CLEANING FURNITURE'S SURFACES

### METAL CLEANING



To preserve their original appearance, most of our materials require **basic precautions**. They can be damaged, to a varying extent, depending on the product type, by:

- **mechanical** factors: wear and tear, scratches, impact, distortion, etc.
- **chemical** factors: acids, bases, solvents, etc.

Our surfaces must therefore be cleaned in accordance with the following principles:

- **Systematically carry out a preliminary test on non-visible and restricted areas** to determine compatibility (e.g. under the seat or table top)
- **Do not use abrasive products** or products which may affect the condition of the surface (abrasive sponges, wire wool, pads, scouring creams or powders, dyed textiles which may leave marks, etc.)
- **Do not use aggressive chemicals** (solvents, alkaline detergents, etc)
- Beware of retention zones in which cleaning products can be trapped, leading to further damage
- **Comply with the conditions of use** of the products used (dilution, diffusion, application time, etc.)
- **Do not use high pressure equipment**
- If your table has a solid top, tilt it slightly, using the **Fermob leg risers supplied**, to prevent water from accumulating when it is not in use,
- Avoid prolonged contact with objects that may retain water or moisture (such as flower pots or trivets),
- **Never cover the furniture with non-breathable tarpaulin** or plastic sheeting that will retain moisture,
- Clean off any bird droppings as soon as possible, as these are particularly corrosive.



**Our recommendations are as follows:**



**Use soapy water** or **Fermob multi-purpose cleaner**.



Apply with a **soft sponge** or a white soft cloth made of a non-abrasive material.

**Rinse with water.**



**Wipe carefully** with a microfibre cloth to prevent limescale marks.



For lights rated below IPX4 or with wall-mounted power supply\*: **use a clean, damp cloth**.

\*Remember to turn off wall switch & cut power.



#### FOCUS ON MILD MULTI-PURPOSE CLEANER

- Allows you to clean all your Fermob furniture
- Effective on metal (aluminium or painted steel), Outdoor Technical Fabric (OTF), woven resin, synthetic fibres... (Do not use on teak)





**The following products may be used** but they should be diluted and subject to extensive compatibility testing:

- Ethanol
- Bleach (98% dilution)



**We strongly advise against the following non-exhaustive list of products;** unless appropriately diluted, they could damage our materials:

- Alcohol, isopropanol
- Petrol, white spirit, solvents, dissolvents
- Hydrocarbons, caustic soda, ammonia
- Alkaline detergents (pH>9)
- Acids
- Polish
- Products to remove graffiti
- etc.

## OUTDOOR TECHNICAL FABRIC (OTF) AND POLYMER THREAD CLEANING



**Use soapy water** or **Fermob multi-purpose cleaner.**



Spray or apply with a **soft sponge**. Rub gently with a soft brush.  
**Rinse with water.**



**Wipe clean.**

Very dirty surfaces may require a second application.

## TEAK CLEANING

If you have left your garden furniture outside, it will have turned grey over time. You can get it back to its original colour by following the following steps :



**Wash the teak** with a brush and soapy water.



**Sand the teak** with sandpaper (grade 120 or 240 depending on how grey it is) in the direction of the wood grain.



**Wipe the sanded area** with a clean cloth to remove impurities.

You can also use a degreasing product, which is more aggressive to the wood and is therefore not recommended as an initial approach.

Please note that the slats of the Natural Bistro chair are not made of teak, but of Textrol® treated wood to protect it from the weather. By its very nature, wood requires special care: a wood seal such as Textrol® should be regularly applied, with the prior application of a wood cleaner such as Net-Trol®, if necessary.

## FABRIC CLEANING

PRE-WASHING AND ROUTINE CLEANING – Cushion in place on the furniture



**Vacuum your cushion or, if there are any stains, quickly dab them** to absorb the liquid with a paper towel, cloth or towel.



**Wash the fabric** with a soft brush and soapy water (washing-up liquid or mild soap), giving special attention to any stains.



**Rinse with clean water**  
**Allow to dry in the open air.**

WASHING – Removed cushion cover

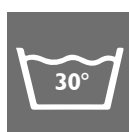

**Machine-wash on a gentle cycle** compatible materials, following the recommendations on the label.  
Close the zip fasteners first.  
**Allow to dry in the open air.**



**Dry-iron the cover** if required.



**At the end of the season, wash the cushion covers before tidying away/storing your cushions indoors, protected from dust and moisture.**



**We strongly advise against:**

- dry cleaning,
- the use of devices such as high-pressure cleaners, tumble dryers and steam irons
- the use of abrasive liquids.

## LEATHER CLEANING



The best way to care for leather is to dust **it regularly** with a soft cloth.

To preserve the natural beauty of this carefully selected leather, we recommend **protecting the item of furniture from damp**. If, in spite of your precautions, the leather gets wet, **wipe up any damp immediately** with a soft, dry, lint-free cotton cloth and leave it to dry slowly in a warm room.



- Your leather item of furniture is for **indoor use only**. We also recommend keeping it away from **bay windows, radiators and fireplaces**.
- Do not use your leather item of furniture for any other purposes and protect it from contact with sharp objects that may damage the materials.
- Prevent any contact between your leather item of furniture and materials whose colours may not be fixed and that may stain the leather, such as untreated materials (e.g. new jeans).



- **We do not recommend using specific leather cleaning products available in shops.** These may not be suitable for our leather.
- **Do not use detergent products** (alcohol, solvent, diluent, etc.), greasy products (lipstick) or inks (felt-tip or other pens) that may cause irreparable, indelible damage to your leather.

## RESTORATION OF THE FURNITURE



We advise that any scrapes / missing paint should be repaired immediately to prevent corrosion of the metal (steel or aluminium). We recommend this type of touch-up for the parts of your furniture that cannot be seen.

## RUSTPROOFING

If you observe minor corrosion on your **steel furniture** (most often located at the welds, rivets, joints, under the tops or under the seats) rivets, joints, under the trays or under the seats) the **Fermob anti-rust spray** will allow you to stop the spread of rust:



Follow the cleaning instructions to **clean the oxidised surface**.  
**Wipe carefully.**



**Sand the rusted area** with sandpaper (grade 120 to 240), and then **wipe the sanded area with a clean cloth** to remove impurities.



**Before using the rust-proofing product, shake the spray can well.** Do a test spray onto a piece of cardboard.  
**Apply the rust-proofing product** in a sweeping action.  
**Allow to dry** for 5 to 10 minutes.

Move to the painting stage, where you will be using the **touch-up pen** or the **paint spray**.

You do not need to use a rust remover on **aluminium furniture**. Simply sand and repaint.

## PAINT TOUCH-UP

Wear and tear of painted items (scratches, stains, etc.), whether natural or through failure to follow our precautions for use, can be alleviated on Textured shades (but not on Smooth shades) by applying paint spray:



Follow the cleaning instructions to **clean the surface to be painted**.  
**Wipe carefully.**



**Before using the paint spray, shake the spray can well.** Do a test spray onto a piece of cardboard.  
**Apply the paint in a sweeping action**, starting the application on the outside of the product to avoid any risk of projection.  
**Allow to dry** for 5 to 10 minutes.

A second coat of paint can be applied.

If the item has only had a slight knock, you could use the **touch-up pen** instead.

## TREATMENT OF RINGS

A build-up of water combined with exposure to the sun can cause rings (whitish marks) to appear on your furniture.

This can happen if the furniture is not used as per Fermob's recommendations, such as if you:

- Use non-breathable protective covers
- Use a tarpaulin or plastic sheeting
- Store objects such as flower pots or trivets on top of the furniture
- Stack tables top-to-top
- Stack chairs and benches seat-to-seat or seat-to-table top
- Store a solid-top table over winter or for a prolonged period of non-use without using a table block.  
Note: The table blocks (supplied with the product and/or available separately) creates a slope to stop water pooling on the table top.



**We recommend treating any rings as soon as they appear.**



Follow the cleaning instructions to  
**clean the problem area.**  
**Wipe carefully.**



**Use a heat gun** (2,000 W, max. 630°C).  
**Slowly move the heat gun over the problem area, holding it  
around 5 cm away from the surface.**

The rings will gradually disappear.

**Allow the surface to cool** before using or  
cleaning the furniture.



**To see all our videos, visit our website at  
[www.fermob.com](http://www.fermob.com) or scan this QR codes :**



Care  
& winter storage



Touch up  
& repair

## ROLL-OUT OF A SOLUTION FOR PROFESSIONALS

We are able to offer to our professional clients a **viable disinfectant solution** with:

- **Two types of hand-held spray bottles**, developed specifically for COVID-19 by the company Berthoud, with a volume of 1 litre (small size) or 5 litres (large size).
- **A professional disinfectant** (called HAGRAL SPRAY SR), ready to use, doesn't require rinsing, is a virucide, according to the decree of 13 March 2020, is **compatible with surfaces which are in contact with food and is colourless and odourless**. A 98% diluted bleach solution may also be appropriate.



Professional disinfectant  
HAGRAL SPRAY SR



1 Liter      5 Liters  
Hand-held spray bottles  
Berthoud

### CORRELATIONS ESTABLISHED FOLLOWING APPLICATION TESTS

#### Large size 5L

- Surface covered **76 m<sup>2</sup>** (7.5 seconds/m<sup>2</sup>), or about 50 Alizé sunloungers (15 seconds/sunlounger)

#### Small size 1L

- Surface covered **15 m<sup>2</sup>** (15 seconds/m<sup>2</sup>), or about 30 Bistro chairs (15 seconds/chair)

*Under no circumstances can these two services constitute grounds for liability on the part of Fermob with regard to the product's appearance, their virucidal power or any other consequence related to their use.*

## ADDITIONAL ADVICE

A non-exhaustive list of household products including degreasers, disinfectants, antibacterial products, sanitisers, hydroalcoholic gel, fungicides, virucides and multi-purpose products (Sanytol, Cif, La Croix, Mr Clean, etc.) have been tested in our laboratory. **Most of these commercial products are diluted or have a neutral pH and do not damage our materials.**

*This advice is provided in addition and is compatible with the general recommendations above; under no circumstances can this advice constitute grounds for liability on the part of Fermob with regard to the product's appearance, their virucidal power or any other consequence related to their use.*

## SYMBOLS

### MARKET



Specialist Superstores

### COLOURS



No. of available colours for the product

### FABRIC CHARACTERISTICS



Machine washable at 30°C

# COVERS & LEG RISERS

## 3150 - CHAIR & ARMCHAIR STACK COVER



Polyester fabric  
 Max. storage capacity: 36 chairs and armchairs  
 Cadiz, Facto, Lorette, Luxembourg, Monceau, Stripe and Studie  
 Do not use as a winter cover

315054 ● Light Grey

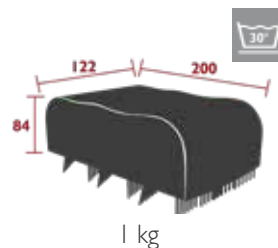

## 8970 - PROTECTIVE COVER FOR SUNLOUNGERS



Tissu outdoor polyester  
 Storage capacity: 2-5 sunloungers  
 Ties to hold the cover in place  
 Do not use as a winter cover  
Compatible with :  
 XS SUNLOUNGER - ALIZÉ  
 SUNLOUNGER - ALIZÉ

897054 ● Light Grey

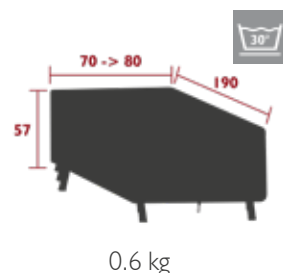

## 3151 - PROTECTIVE COVER 160 X 100 CM FOR TABLE

DESIGN BY STUDIO FERMOB



Ties to hold the cover in place  
 Storage bag sewn into cover  
 Do not use as a winter cover  
Compatible with :  
 TABLE 140 X 80 CM - BELLEVIE  
 MID-HEIGHT TABLE 140 X 80 CM - BELLEVIE  
 HIGH TABLE 140 X 80 CM - BELLEVIE  
 TABLE 160 X 80 CM - CALVI  
 HIGH TABLE 160 X 80 - CALVI  
 TABLE 160 X 80 CM - COSTA  
 TABLE 146 X 80 CM - MONCEAU  
 TABLE WITH 2 EXTENSIONS 149/234 X 100 CM - RIBAMBELLE  
 TABLE WITH 3 EXTENSIONS XL 149/299 X 100 CM - RIBAMBELLE  
 OVAL TABLE 160 X 90 CM - LORETTE  
 OVAL TABLE 160 X 90 CM - OPÉRA+

315154 ● Light Grey



## 3152 - PROTECTIVE COVER 210 X 100 FOR TABLE

DESIGN BY STUDIO FERMOB



Ties to hold the cover in place  
 Storage bag sewn into cover  
 Do not use as a winter cover  
Compatible with :  
 TABLE 196 X 90 CM - BELLEVIE  
 TABLE 196 X 90 CM - BELLEVIE PREMIUM  
 TABLE WITH EXTENSIONS 200/300 X 100 CM - BIARRITZ  
 TABLE 195 X 95 CM - CALVI  
 TABLE 194 X 94 CM - MONCEAU  
 TABLE 180 X 100 CM - ROMANE  
 TABLE WITH EXTENSIONS 200/300 x 100 CM - ROMANE

315254 ● Light Grey





# COVERS & LEG RISERS

289501 - SET OF 2 LEG RISERS



Steel

Wedge blocks under two legs on the same side of the table, across its width, to create a slope and prevent water from pooling on the surface

Compatible with :

TABLE 196 X 90 CM - BELLEVIE  
TABLE 140 X 80 CM - BELLEVIE  
TABLE 196 X 90 CM - WITH STORAGE - BELLEVIE  
MID-HEIGHT TABLE 140 X 80 CM - BELLEVIE  
HIGH TABLE 140 X 80 CM - BELLEVIE  
TABLE 196 X 90 CM - BELLEVIE PREMIUM  
TABLE WITH EXTENSIONS 200/300 X 100 CM - BIARRITZ  
TABLE 195 X 95 CM - CALVI  
TABLE 160 X 80 CM - CALVI  
HIGH TABLE 160 X 80 - CALVI  
TABLE 140 X 140 CM - CALVI  
TABLE 143 X 143 CM - CRAFT  
OVAL TABLE 160 X 90 CM - OPÉRA+  
TABLE Ø 117 CM - OPÉRA+  
TABLE WITH 2 EXTENSIONS 149/234 X 100 CM - RIBAMBELLE  
TABLE WITH 3 EXTENSIONS XL 149/299 X 100 CM - RIBAMBELLE  
TABLE Ø 137 CM - ROMANE  
TABLE 180 X 100 CM - ROMANE  
TABLE WITH EXTENSIONS 200/300 x 100 CM - ROMANE  
TABLE Ø 117 CM - SO'O

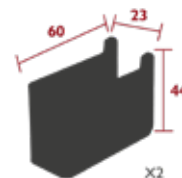

# MAINTENANCE

2865 - TOUCH-UP SPRAY (150 ML)



Paint spray  
Covers up scratches in the exact colour of your furniture  
Covers a surface of 0,5–0,6m<sup>2</sup>

2973 - TOUCH-UP PEN (15 G)



Precision paint touch-up pen  
Covers up scratches in the exact colour of your furniture

000920 - RUST-PROOFING PRODUCT (150 ML)



Ready-to-use spray  
Stops rust spreading before painting

000901 - MULTI-PURPOSE CLEANER (500 ML)



Ready-to-use spray  
For cleaning all Fermob furniture  
Works on metal (aluminium or painted steel), Outdoor Technical Fabric (OTF), woven resin, synthetic fibres... (do not use on teak)

# SPARE PARTS FOR LIGHTING



Following marketing, our **continuous improvement process** allows us to **improve the user experience** and **extend the life span** of our **durable eco-designed products**.

Fermob **considers the design** of its lighting products to **make them easier to disassemble**. **Several components can be replaced**. See below:

## APLÔ

364600 - USB-C CABLE H24 LAMP



Compatible with :  
LAMP H.24 CM - APLÔ

364600  White

344200 - CONTROL BOARD FOR H.24 LAMP

NEW



Compatible with :  
LAMP H.24 CM - APLÔ

344100 - BATTERY FOR H.24 LAMP

NEW



Compatible with :  
LAMP H.24 CM - APLÔ

344000 - DIFFUSER FOR H.24 LAMP

NEW



Compatible with :  
LAMP H.24 CM - APLÔ

344000      Transparent

# BALAD

364400 - USB-C CABLE X3 H1 2 LAMPS



Compatible with :  
SET OF 3 LAMPS BAMBOO H.12 CM - BALAD  
SET OF 3 LAMPS H.12 CM - BALAD

364400  Blanc

366000 - BATTERY-POWERED LIGHTING MODULE FOR H.12 X3 LAMP

NEW



Compatible with :  
SET OF 3 LAMPS H.12 CM - BALAD  
SET OF 3 LAMPS BAMBOO H.12 CM - BALAD

366200 - DIFFUSER FOR H.12 LAMP

NEW



Compatible with :  
SET OF 3 LAMPS BAMBOO H.12 CM - BALAD  
SET OF 3 LAMPS H.12 CM - BALAD

366200    Transparent

# BALAD

364100 - USB CABLE



Compatible with :  
LAMP BAMBOO H.25 CM - BALAD  
LAMP H.25 CM - BALAD  
LAMP H.38 CM - BALAD  
LAMP BAMBOO H.38 CM - BALAD  
LAMP H.41 CM - MOOON!

364100  Blanc

366300 - BATTERY-POWERED LIGHTING MODULE FOR H.25 LAMP

NEW



Compatible with :  
LAMP BAMBOO H.25 CM - BALAD  
LAMP H.25 CM - BALAD

366400 - DIFFUSER FOR H.25 LAMP

NEW



Compatible with :  
LAMP BAMBOO H.25 CM - BALAD  
LAMP H.25 CM - BALAD

366400  Transparent

366500 - BATTERY-POWERED LIGHTING MODULE FOR H.38 LAMP

NEW



Compatible with :  
LAMP BAMBOO H.38 CM - BALAD  
LAMP H.38 CM - BALAD

# BALAD

366600 - DIFFUSER FOR H.38 LAMP

NEW



Compatible with :  
LAMP BAMBOO H.38 CM - BALAD  
LAMP H.38 CM - BALAD

366600      Transparent

284400 - BAG OF SCREWS FOR OFFSET STAND



Compatible with :  
OFFSET STAND - BALAD

2814A - BAG OF SCREWS FOR SPIKE STAND

NEW



Compatible with :  
SPIKE STAND - BALAD

281400 - 6 PADS AND CLIP FOR STANDS



Compatible with :  
UPRIGHT STAND - BALAD  
SPIKE STAND - BALAD  
OFFSET STAND - BALAD

281400      Noir

# HOOPIK

355000 - POWER SUPPLY FOR STRING LIGHTS L. 1200 CM

NEW



Compatible with :  
STRING LIGHTS L1 200 CM – TYPE E & F - HOOPIK  
STRING LIGHTS L1 200 CM – TYPE J - HOOPIK  
STRING LIGHTS L1 200 CM - TYPE I - HOOPIK

355000      Black

539000 - FERMOB MAGNET CABLE

NEW



Compatible with :  
LAMP H.41 MAX - MOOON!  
LAMP H.27 CM - OTO  
LAMP Ø24 CM - HOOPIK  
LAMP H.30 CM - ULLI

539000      Black

# INOÛI

364500 - CHARGING BASE FOR H44 LIGHTING STOOL



Compatible with :  
LIGHTING STOOL H.44 CM - INOÛI  
LAMP H.63 CM - MOOON!  
LAMP H.134 CM - MOOON!

364500       Blanc

331100 - LIGHTING MODULE FOR H.44 LIGHTING STOOL

NEW



Compatible with :  
LIGHTING STOOL H.44 CM - INOÛI

331000 - BATTERY FOR H.44 LIGHTING STOOL

NEW



Compatible with :  
LIGHTING STOOL H.44 CM - INOÛI



# MOOON!

539000 - FERMOB MAGNET CABLE

NEW



Compatible with :  
LAMP H.41 MAX - MOOON!  
LAMP H.27 CM - OTO  
LAMP Ø24 CM - HOOPIK  
LAMP H.30 CM - ULLI

539000      Black

364100 - USB CABLE H41 LAMP

NEW



Compatible with :  
LAMP H.41 CM - MOOON!  
LAMP H.25 CM - BALAD  
LAMP H.38 CM - BALAD  
LAMP BAMBOO H.25 CM - BALAD  
LAMP BAMBOO H.38 CM - BALAD

364100       White

539500 - BATTERY-POWERED LIGHTING MODULE FOR H.41 LAMP

NEW



Compatible with :  
LAMP H.41 CM - MOOON!

539600 - BATTERY FOR H.41 LAMP

NEW



Compatible with :  
LAMP H.41 CM - MOOON!

# MOOON!

539400 - DIFFUSER FOR H.4 I LAMP

NEW



Compatible with :  
LAMP H.4 I CM - MOOON!

539400      Transparent

539700 - LIGHTING MODULE FOR H.4 I MAX LAMP

NEW



Compatible with :  
LAMP H.4 I MAX - MOOON!

539800 - BATTERY FOR H.4 I MAX LAMP

NEW



Compatible with :  
LAMP H.4 I MAX - MOOON!

364500 - CHARGING BASE FOR H63 & H I 34 LAMPS

NEW



Compatible with :  
LAMP H.63 CM - MOOON!  
LAMP H. I 34 CM - MOOON!  
LIGHTING STOOL H.44 CM - INOUÏ

364500       White

539300 - LIGHTING MODULE FOR H.63 & H. I 34 LAMPS

NEW



Compatible with :  
LAMP H.63 CM - MOOON!  
LAMP H. I 34 CM - MOOON!

# MOOON!

539200 - BATTERY FOR H.63 & H.134 LAMPS

NEW



Compatible with :  
LAMP H.63 CM - MOOON!  
LAMP H.134 CM - MOOON!

539100 - DIFFUSER FOR H.63 & H.134 LAMPS

NEW

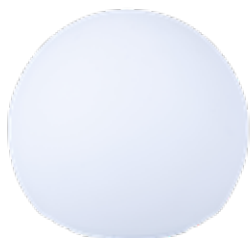

Compatible with :  
LAMP H.63 CM - MOOON!  
LAMP H.134 CM - MOOON!

539100      Transparent

364800 - LIGHTING MODULE FOR Ø15 WALL LIGHT



Compatible with :  
WALL LIGHT Ø15 CM - MOOON!

364900 - POWER SUPPLY WALL LIGHT Ø15



Compatible with :  
WALL LIGHT Ø15 CM - MOOON!

364700 - GLASS DIFFUSER Ø15



Compatible with :  
WALL LIGHT Ø15 CM - MOOON!  
TRIPLE PENDANT LIGHTS Ø15 CM - MOOON!  
LAMP H.41 MAX - MOOON!

364700      Transparent

# MOOON!

538600 - LIGHTING MODULE FOR TRIPLE PENDANT LIGHTS Ø15

NEW



Compatible with :  
TRIPLE PENDANT LIGHTS Ø15 CM - MOOON!

538500 - POWER SUPPLY FOR TRIPLE PENDANT LIGHTS Ø15

NEW



Compatible with :  
PENDANT LIGHT Ø25 CM - MOOON!

538900 - LIGHTING MODULE FOR PENDANT LIGHTS Ø25

NEW



Compatible with :  
PENDANT LIGHT Ø25 CM - MOOON!

538800 - POWER SUPPLY FOR PENDANT LIGHTS Ø25

NEW



Compatible with :  
TRIPLE PENDANT LIGHTS Ø15 CM - MOOON!

538700 - GLASS DIFFUSER Ø25

NEW



Compatible with :  
PENDANT LIGHT Ø25 CM - MOOON!

538700      Transparent

539000 - FERMOB MAGNET CABLE

NEW



Compatible with :  
LAMP H.41 MAX - MOOON!  
LAMP H.27 CM - OTO  
LAMP Ø24 CM - HOOPIK  
LAMP H.30 CM - ULLI

539000    Noir

399900 - BATTERY FOR H.27 LAMP

NEW



Compatible with :  
LAMP H.27 CM - OTO

# MARKETING TOOLS

AVAILABLE

Unit price exc. VAT

## BRAND CATALOGS



BRAND ALBUM  
(From January 2024)  
**Ref : 000440U**

5 €

**NEW**



EXPORT CATALOGUE  
& CONTRACT BOOKLET

5 €

## SALES TOOLS



TECHNICAL BOOKLET  
**Ref : 000410V**

15 €



COLOUR, TREND & MERCHANDISING BOOK  
**Ref : 000413V**

10 €



BELLEVIE MODULAR LEAFLET  
**Ref : 000461V**

5 €

## DISPLAYS



PLACEMAT DISPLAY CASE  
10 removable shelves  
Collapsible  
Mobile, 2 casters for easy movement  
White steel  
**Ref : 000806**

Free when you  
order 160 placemats  
or more  
(2 sets of 8 per colour)



MAGNETIC WALL-MOUNTED COLOUR  
CHART  
Highlight the colour range and help customers  
create their own combinations, step by step.  
**Ref : 000190 - Support**  
**Ref : 000191V - Full colour chart**



DISPLAY CASE  
FERMOB LIGHTING & LUDO  
**Contact your customer department**

Limited quantity.  
Get closer to your  
commercial contact

## DISPLAYS



## BISTRO DISPLAY CASE

An attractive way to present the Bistro chair

Can hold up to 40 chairs; minimum 4 m<sup>2</sup>

L: 130/220 cm (fold-away side panels)

D: 54 cm H: 215 cm

White steel

Quick, simple hook attachment system

Presentation tray can be inclined

Wheels with brake

**Ref : 2966T + 000305T**

Free when you  
order 140 chairs  
and 40 tables  
or more

## COLOURS TOOLS - RETAIL/CONTRACT



## METAL COLOUR CHART (full)

**Ref : 000050V**

12 €



## OTF COLOUR CHART (full)

**Ref : 000180V**

8 €

## MARKETING TOOLS - RETAIL



## PRODUCT LABELS

**Ref : 000820V**

29 €



## LIGHTING PRODUCT LABELS

**Contact your customer department**

15 €



## COLOUR CHART CARD

**Ref : 000403V**

5 €



## SELD-STANDING APLÔ CARDS

**Contact your customer department**

4 €



## SELD-STANDING BALAD CARDS

**Contact your customer department**

4 €



## SELD-STANDING ULLI CARDS

**Contact your customer department**

4 €



## SELD-STANDING MOOON! TABLE LIGHT CARDS

**Contact your customer department**

4 €

SELD-STANDING MOOON!  
PENDANT WALL LIGHTS CARDS

**Contact your customer department**

4 €

## MARKETING TOOLS - RETAIL



LOGO STICKERS 60cm (to be placed inside the window)  
**Ref : 000803U**

5 €



FERMOB BAGS- SMALL 38/10x28 (lot de 50)

**Ref : 000850** ..... 40 €

FERMOB BAGS - MEDIUM 46/21x36 (lot de 50)

**Ref : 000851** ..... 55 €

FERMOB BAGS - LARGE 60/30x52 (lot de 50))

**Ref : 000852** ..... 75 €



AMBIANCE BANNERS

**Aluminium frame 000691** ..... 60 €

**Visual 1 - Ref : 000235U** ..... 40 €

**Visual 2 - Ref : 000236U** ..... 40 €



BRAND AND PRODUCT VIDEOS

To liven up your sales outlet

Download from [www.fermob.com](http://www.fermob.com)

Available in your  
retailers' area



FERMOB PRODUCT TRAINING DAY

Everything you need to know about Fermob, its history and its products. The training day can be followed by a visit to the production site..

Free, on request to  
your sales  
representative



MERCHANDISING LAYOUT PLAN

To create a display space with winning product/colour combinations and suited to your store circumstances.

(on request from your sales representative)

≤ to 30 m<sup>2</sup> / 175 €

≤ to 70 m<sup>2</sup> / 450 €

≤ to 100 m<sup>2</sup> / 650 €



LIGHTING POS

GLOBAL SUSTAINABLE APPROACH

**Contact your customer department**

4 €



FERMOB.COM

Find detailed information on our website, from your tablet, PC or smartphone.



COLLABORATIVE WELCOME PLATFORM

1 - Place your orders online and track their progress

2 - Find all our media supports instantly (technical booklet, price list, ambient visuals, packshot, etc.)

<https://welcome.fermob.com/> or scan the QR code :





LEGAL NOTICE: Weights and dimensions provided for information purposes only. Photos and texts not contractually binding. The Technical Booklet and all of its contents (items of furniture, texts, photographs, illustrations, diagrams, graphics, logos, etc.) are the exclusive property of Fermob. Fermob is the exclusive owner of all intellectual property rights relating, in particular, to the catalogue and all original designs, drawings, models, patents and trademarks that it contains. It is strictly prohibited to use all or part of these elements without the prior, express authorisation of Fermob. Unauthorised use may result in penalties, in particular those stipulated by the French Intellectual Property Code concerning infringement of copyright (article L. 335-3 and following), drawings and models (article L. 521-1 and following), patents (article L. 615-1 and following) and trademarks (article L. 716-1 and following), and by the French Civil Liability Code (article 1382 and following).

PHOTO CREDITS: Stéphane Rambaud | Tom Watson | Claire Curt | Sébastien Boudot | Julie Ansiau | Maud Chalard | Delphine Chanet | Sébastien Érome | Lucas Fascini | Brigitta Wolfgang Drejer | Véronique Vedrenne | Lucas Fascini | Jean-Pierre Lemoine | Aurélie Lecuyer | Jérôme Galland | Nicolas Mathéus

Code article  
000411V



3 100540 533444

Join us :



[fermob.com](http://fermob.com)

Fermob - Parc Actival - 01 140 Thoissey - France